

Montageanleitung für Metall-Gerätehaus

M110100 / 230 × 230 cm

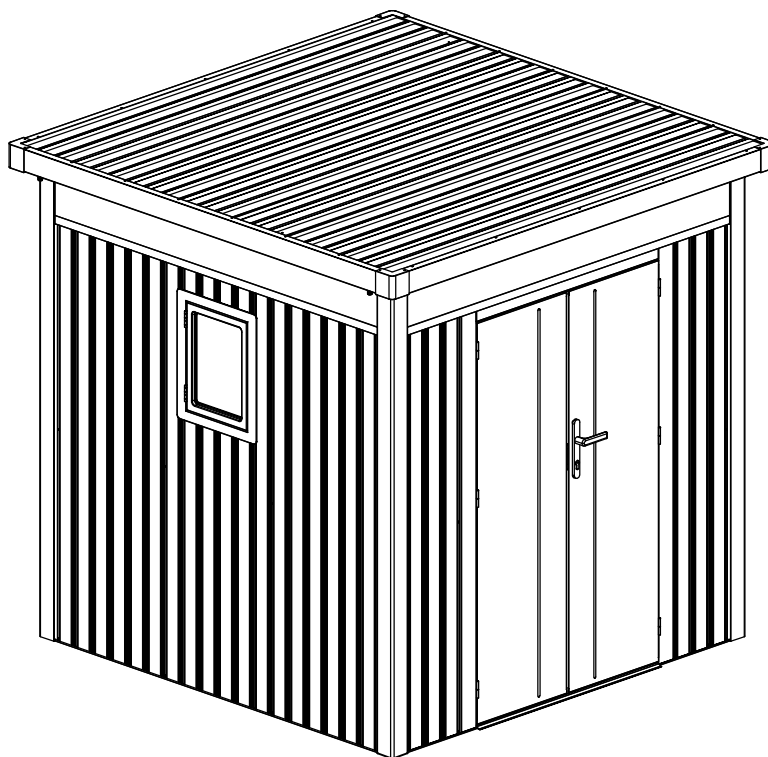

osb onlineshop-baumarkt GmbH

Website: www.onlineshop-baumarkt.de
E-mail: service@onlineshop-baumarkt.de

Erforderliche Werkzeuge & Sicherheitshinweise

Die Montage darf nur mit geeigneten Werkzeugen und unter Einhaltung der nachfolgenden Sicherheitsvorgaben durchgeführt werden. Stellen Sie bitte sicher, dass alle genannten Hilfsmittel vor Beginn der Montage vollständig vorhanden sind.

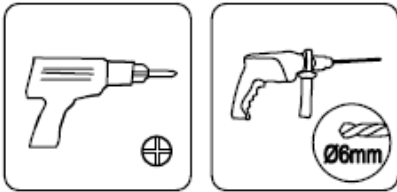

Bohrmaschine / Akkuschauber

Erforderlich ist eine Bohrmaschine bzw. ein Akkuschauber mit **Kreuzschlitz-Bit** sowie einem **6-mm-Bohrer** für Schraub- und Bohrarbeiten.

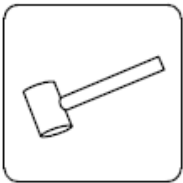

Gummihammer

Zum spannungsfreien Ausrichten und Zusammenfügen der Bauteile ohne Beschädigung der Oberflächen.

Wasserwaage

Zur waagerechten und senkrechten Ausrichtung des Metallgerätehauses. Eine korrekte Ausrichtung ist Voraussetzung für die Passgenauigkeit und Funktion der Bauteile.



Stehleiter (freistehend)

Für Montagearbeiten in der Höhe ist eine standsichere Stehleiter zu verwenden. Die Leiter muss auf einem ebenen, tragfähigen Untergrund aufgestellt werden.

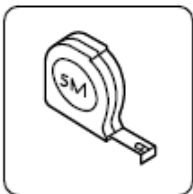

Messwerkzeug

Zur Maßkontrolle werden ein Maßband sowie ein Gliedermaßstab (Zollstock) benötigt.



Persönliche Schutzausrüstung (PSA)

Während der Montage ist geeignete persönliche Schutzausrüstung zu tragen. Dazu gehören Schutzhandschuhe, festes, geschlossenes Schuhwerk sowie lange, geschlossene Kleidung.

Bei Bohrarbeiten oder Arbeiten mit Metallteilen ist geeigneter Augenschutz (Schutzbrille) zu verwenden.

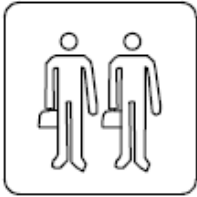

Personenanzahl

Die Montage darf nur mit mindestens zwei Personen durchgeführt werden. Beide Personen müssen körperlich belastbar sein, um Bauteile sicher zu tragen, zu positionieren und zu montieren.

Allgemeine Informationen – Metallgerätehaus

1. Kondenswasserbildung

Metall reagiert auf Temperaturunterschiede, wodurch Kondenswasser entstehen kann. Sorgen Sie für eine regelmäßige Belüftung durch Öffnen von Türen und Lüftungsöffnungen. Kondenswasser ist bei Bedarf zu entfernen. Optional kann ein Antikondensvlies an der Dachinnenseite montiert werden (nicht im Lieferumfang enthalten).

2. Dachausführung

Das Dach ist für den vorgesehenen Einsatzzweck ausgelegt. Veränderungen an der Dachkonstruktion dürfen nur gemäß Herstellerangaben erfolgen. Der Aufbau darf erst nach vollständiger Fertigstellung des Fundaments erfolgen.

3. Fundamenterstellung

Das Metallgerätehaus darf nur auf einem tragfähigen, ebenen Fundament montiert werden. Die Fundamenterstellung muss gemäß beiliegendem Fundamentplan erfolgen. Abweichungen können zu Funktionsstörungen und zum Verlust von Gewährleistungsansprüchen führen.

4. Gebrauchsspuren

Während der Montage und Nutzung können oberflächliche Kratzer oder Druckstellen entstehen. Diese sind material- und nutzungsbedingt und stellen keinen Mangel dar. Bauteile dürfen nicht gezogen, nicht auf harten Untergründen abgelegt und nicht mit spitzen oder scharfkantigen Gegenständen in Kontakt gebracht werden.

5. Wartung und Pflege

Das Metallgerätehaus ist wartungsarm. Reinigen Sie es regelmäßig mit milden Reinigungsmitteln und weichen Tüchern. Scheuernde oder aggressive Reinigungsmittel sind zu vermeiden.

6. Sturmsicherung

Das Gerätehaus muss fachgerecht am Fundament verankert werden. Je nach Standort kann eine zusätzliche Sturmsicherung erforderlich sein. Diese ist in der Regel nicht im Lieferumfang enthalten.

7. Belüftung und Nutzung

Achten Sie auf eine ausreichende Luftzirkulation, insbesondere bei der Lagerung feuchtigkeitsempfindlicher Gegenstände, um Feuchtigkeitsbildung und Korrosion zu vermeiden.

Abmessungen:

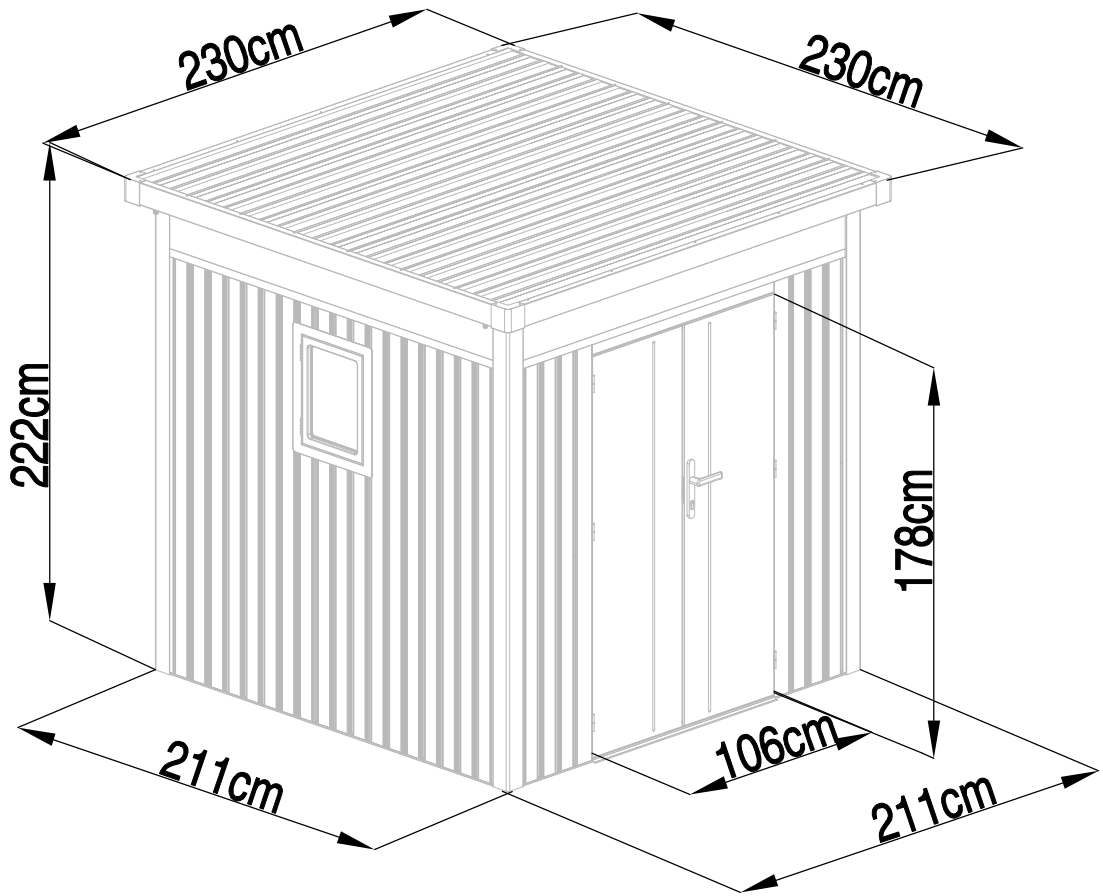

Fundamentplan:

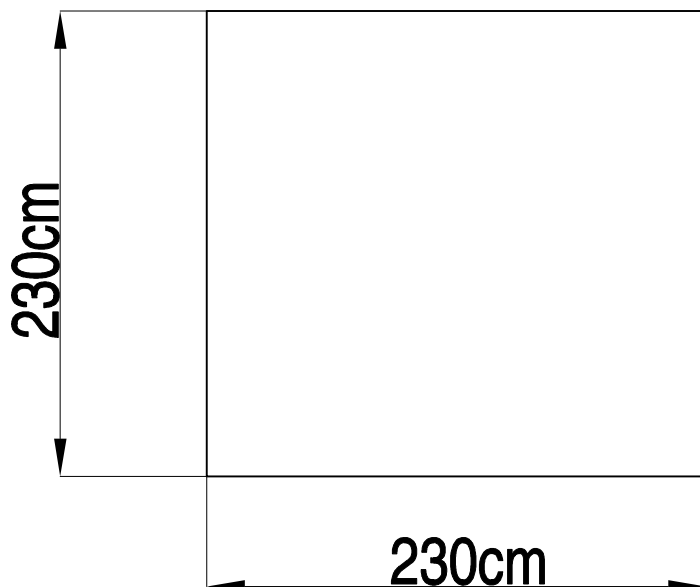

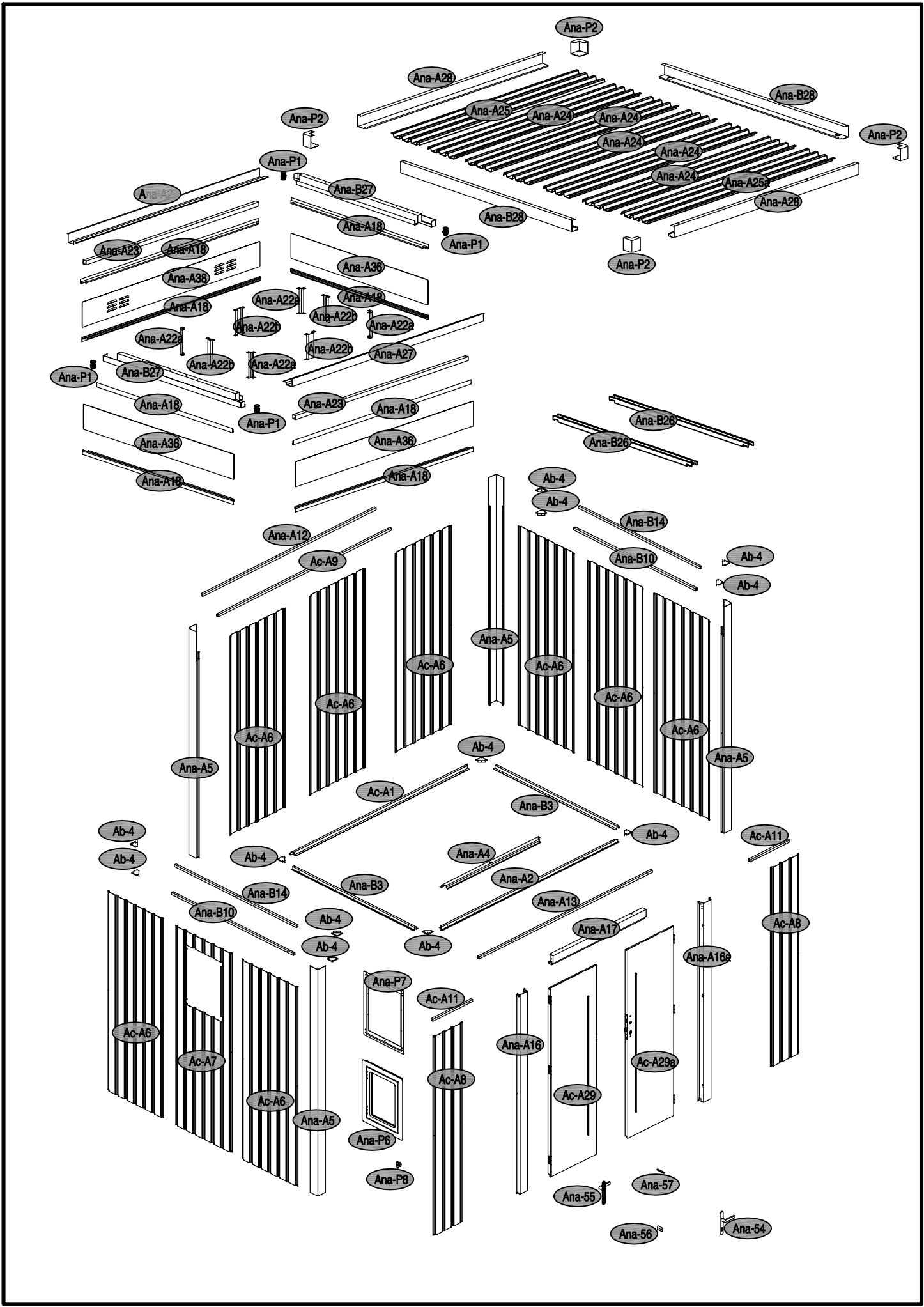

1



Ac-A1 x1



Ana-A2 x1



Ana-B3 x2

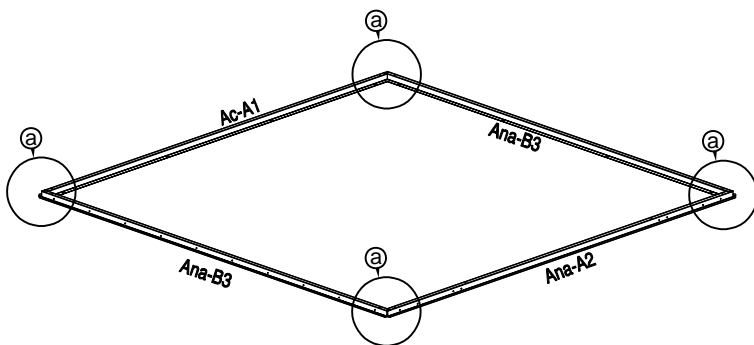
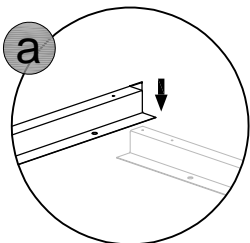

2



Ab-4 x4



Ana-B41 x12

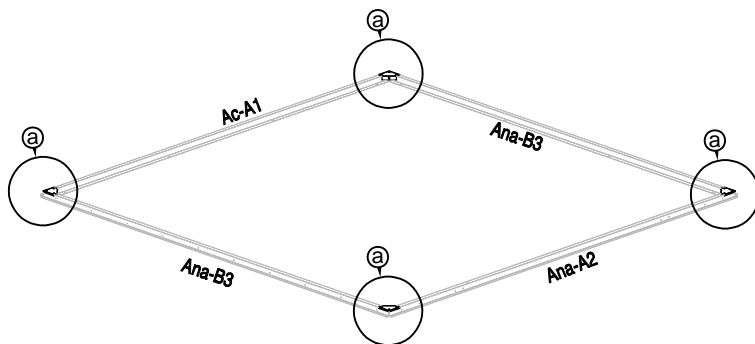
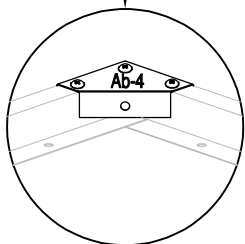
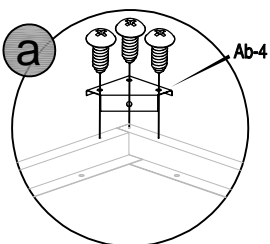

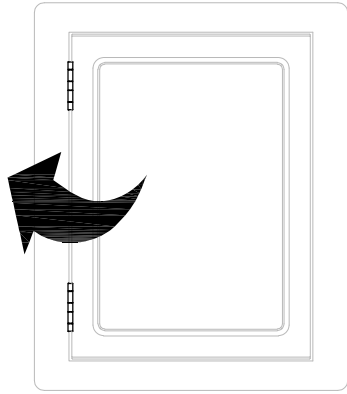

Or

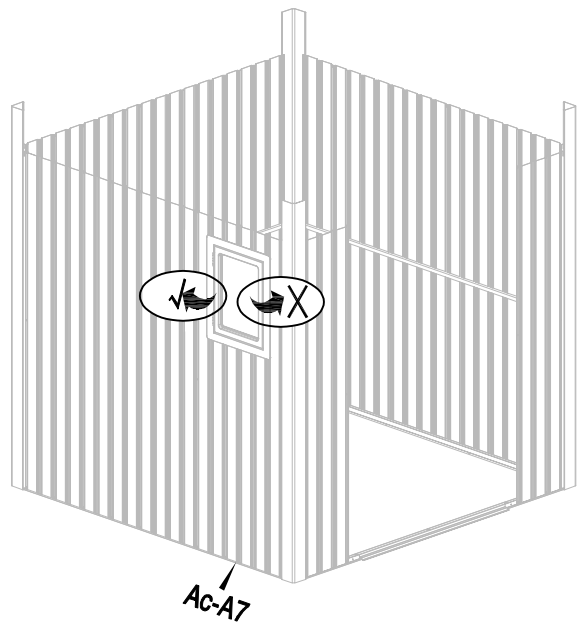
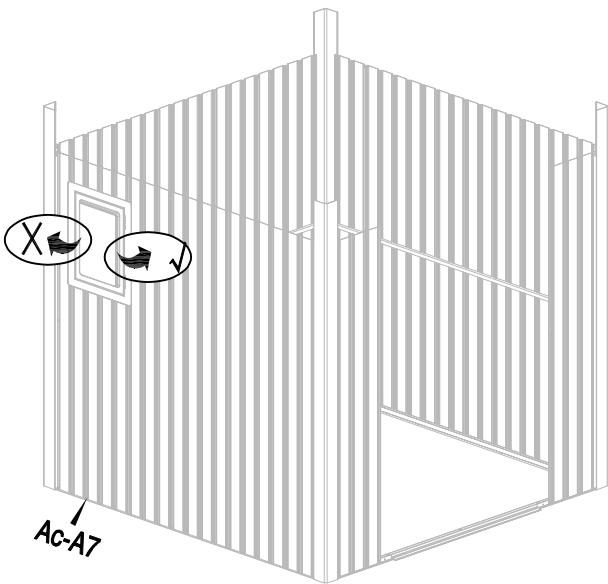
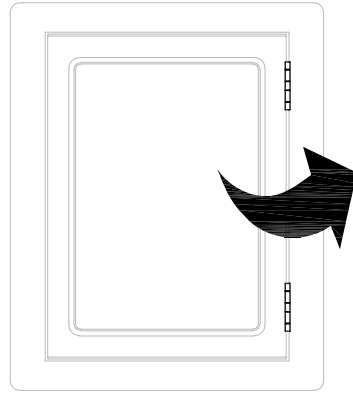

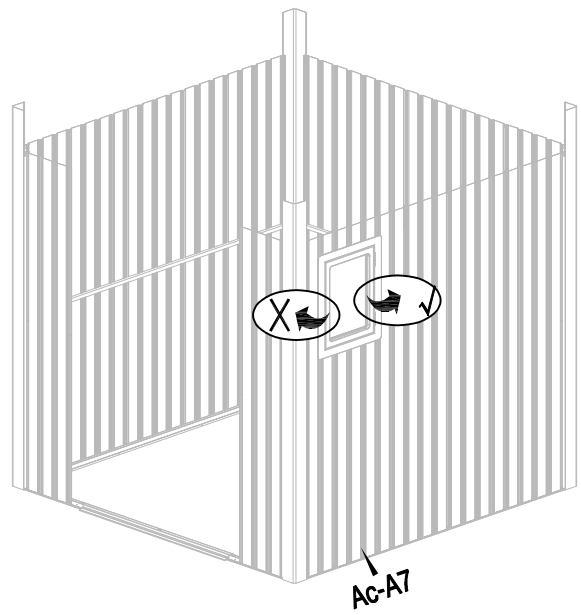
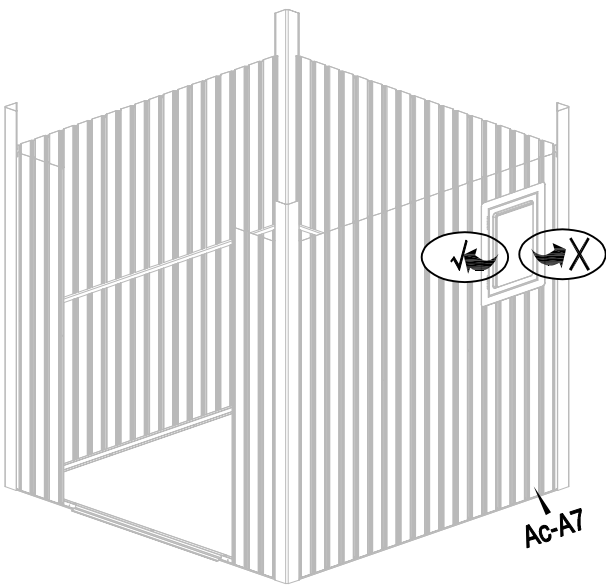
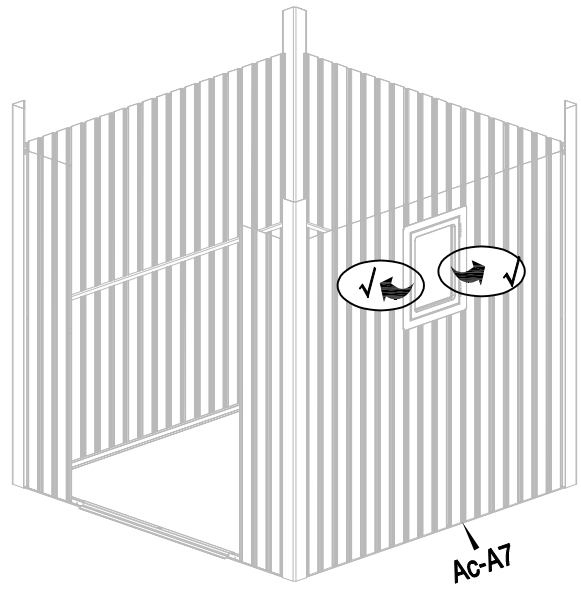
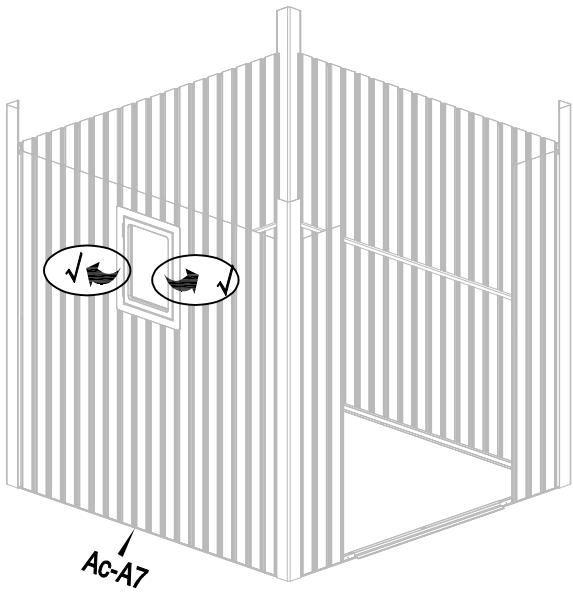

3



Ac-A6 x1



Ana-A5 x1



Ana-B10 x1



Ana-B41 x5



Ana-B40 x5

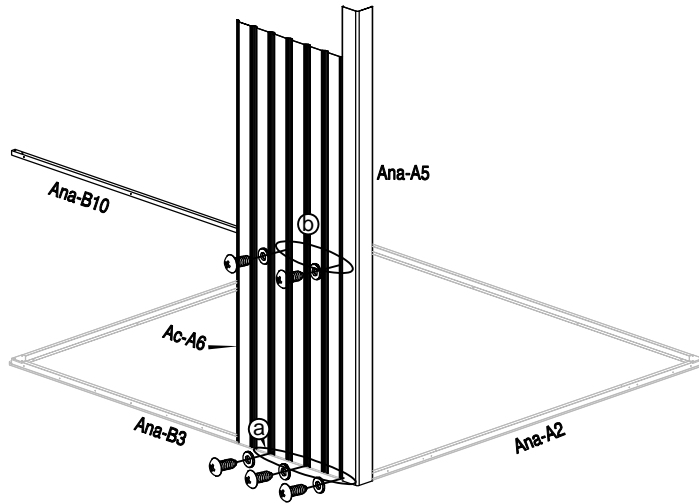
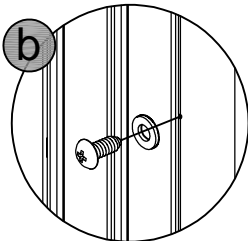
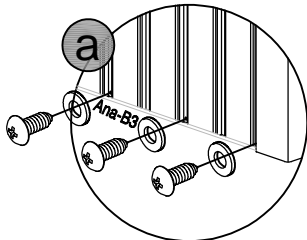

4



Ac-A8 x1



Ac-A11 x1



Ana-B41 x3



Ana-B40 x3

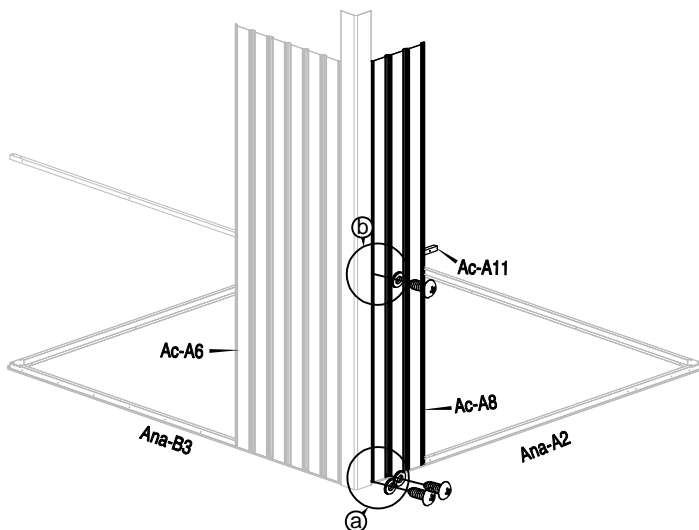
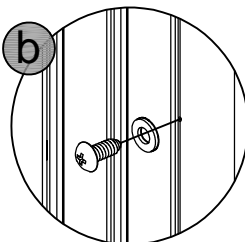
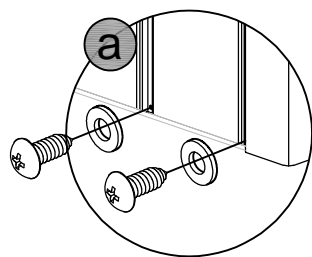

5



Ac-A7 x1



Ana-B41 x5



Ana-B40 x5

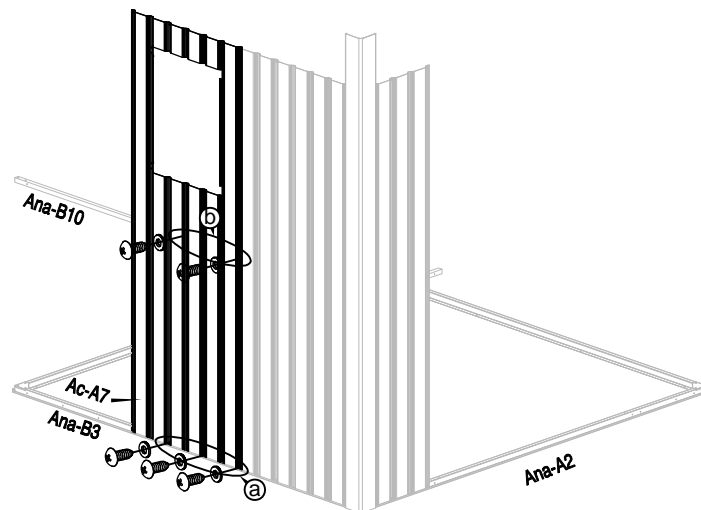
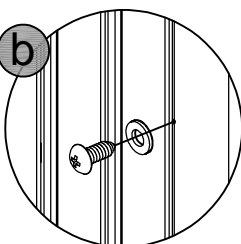
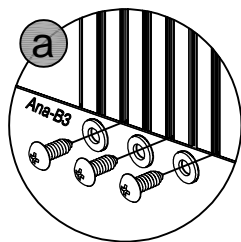

6



Ac-A6 x1



Ana-A5 x1



Ana-B41 x7



Ana-B40 x7

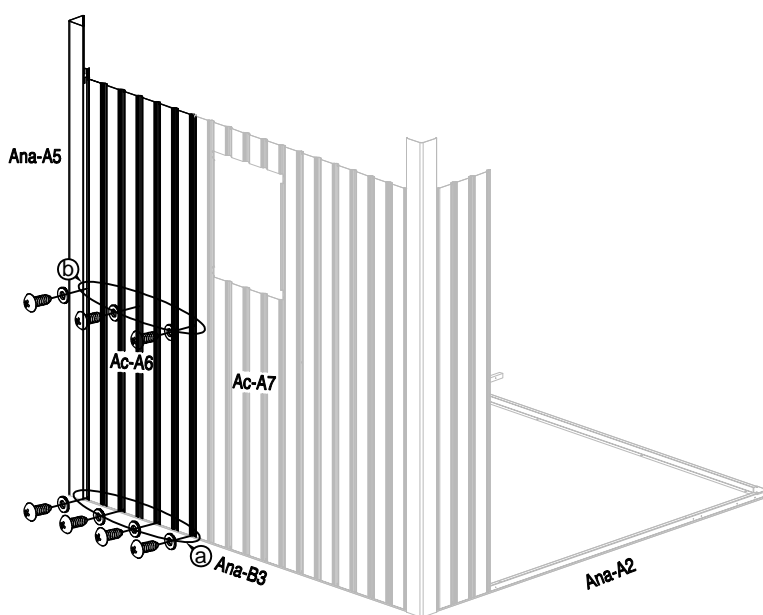
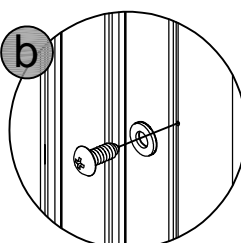
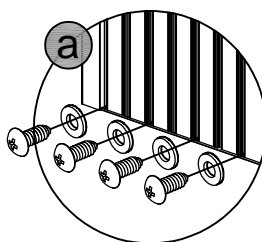

7



Ac-A6 x1



Ac-A9 x1



Ana-B41 x5



Ana-B40 x5

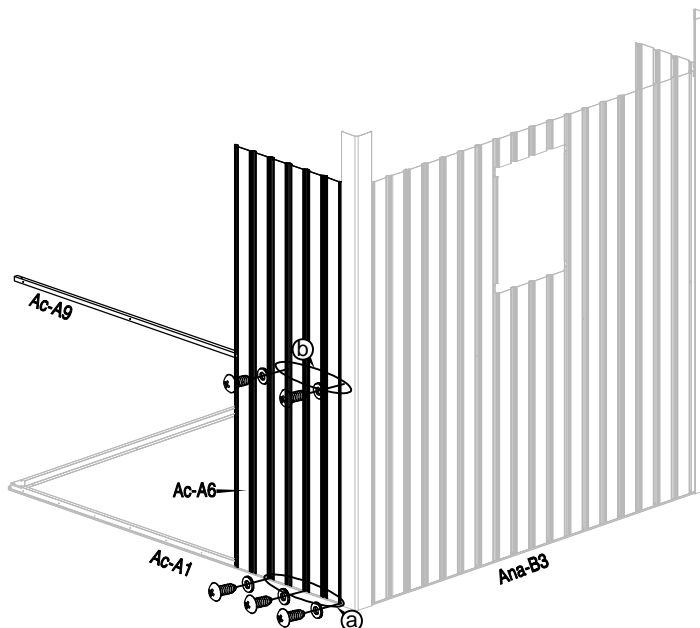
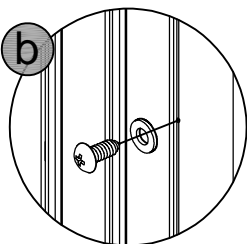
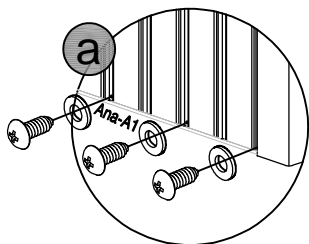

8



Ac-A6 x1



Ana-B41 x5



Ana-B40 x5

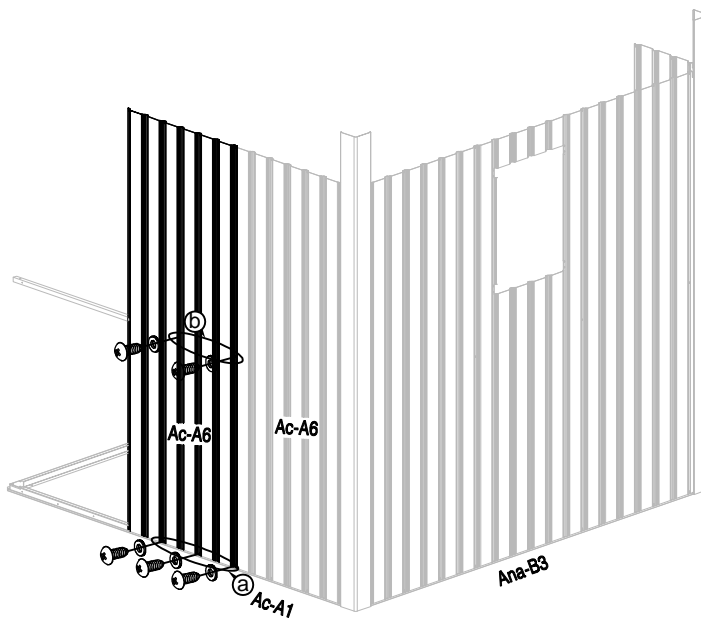
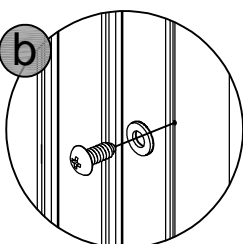
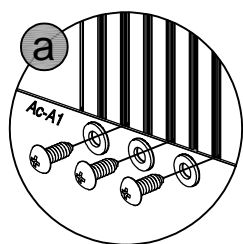

9



Ac-A6 x1



Ana-A5 x1



Ana-B41 x7



Ana-B40 x7

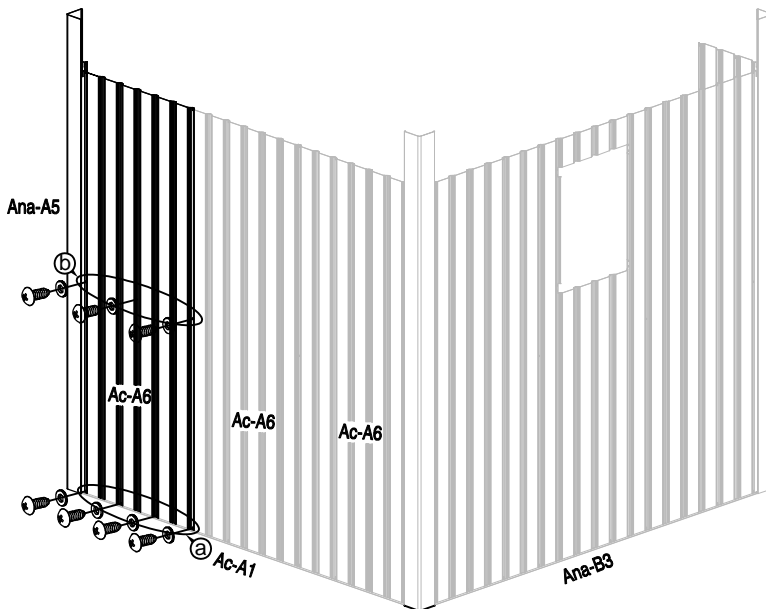
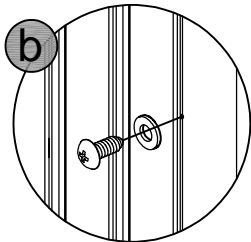
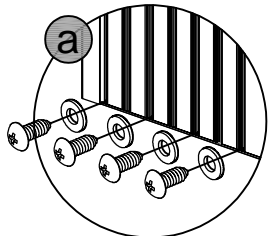

10



Ac-A6 x1



Ana-B10 x1



Ana-B41 x5



Ana-B40 x5

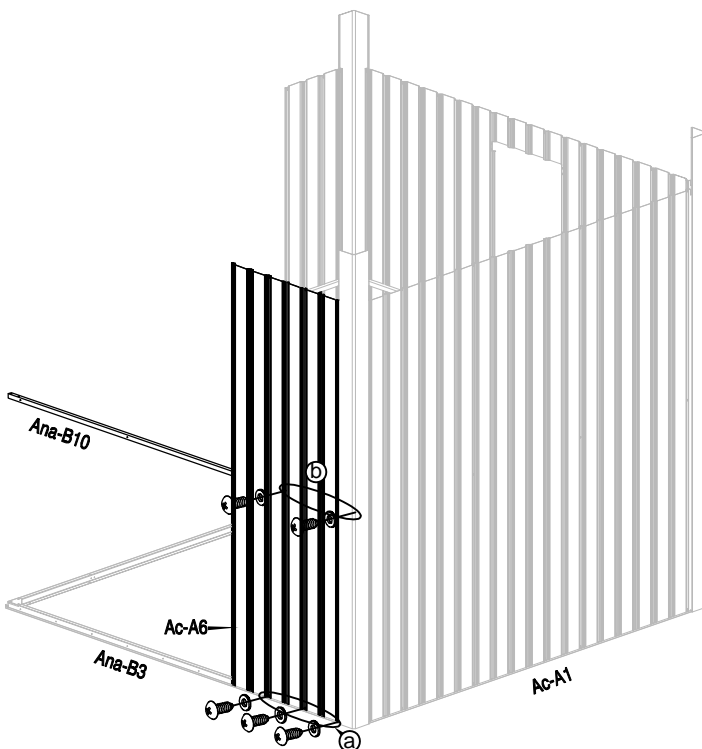
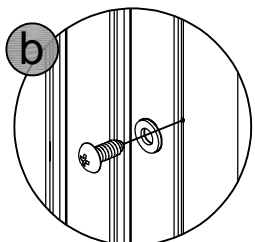
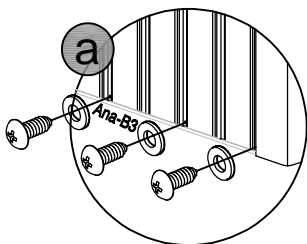

11

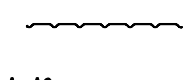

Ac-A6 x1



Ana-B41 x5



Ana-B40 x5

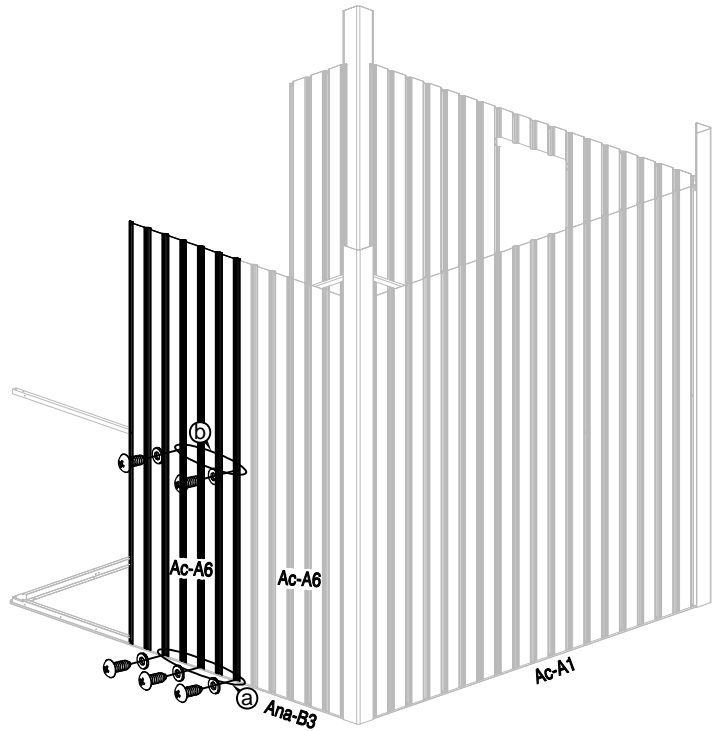
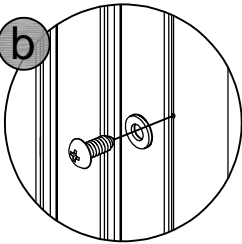
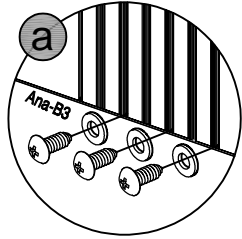

12

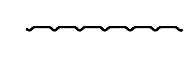

Ac-A6 x1



Ana-A5 x1



Ana-B41 x7



Ana-B40 x7

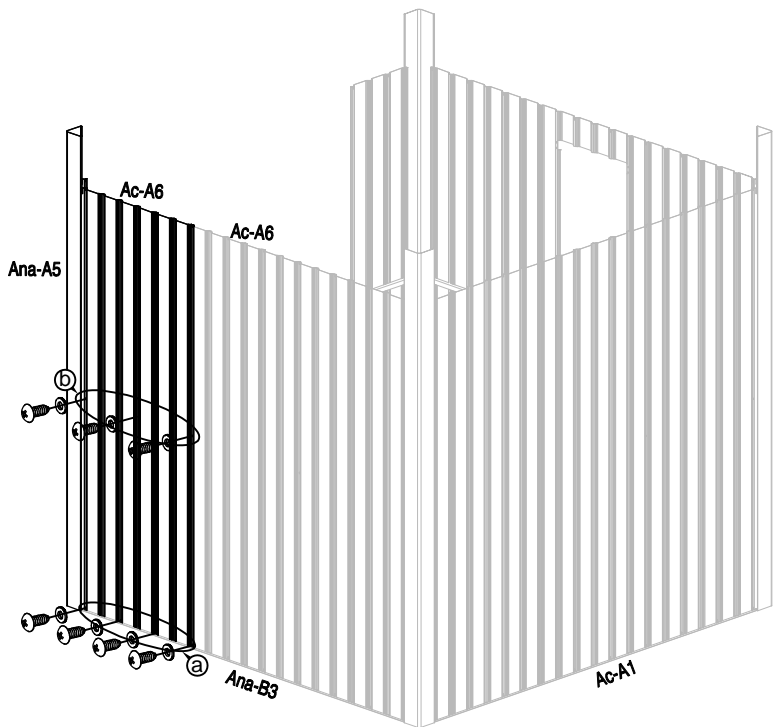
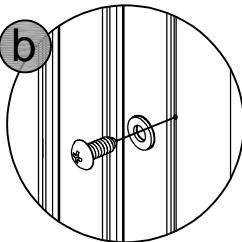
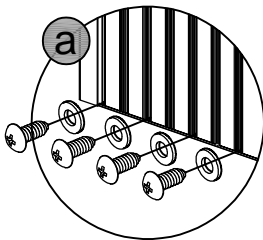

13

Ac-A8 x1

Ac-A11 x1

Ana-B41 x3

Ana-B40 x3

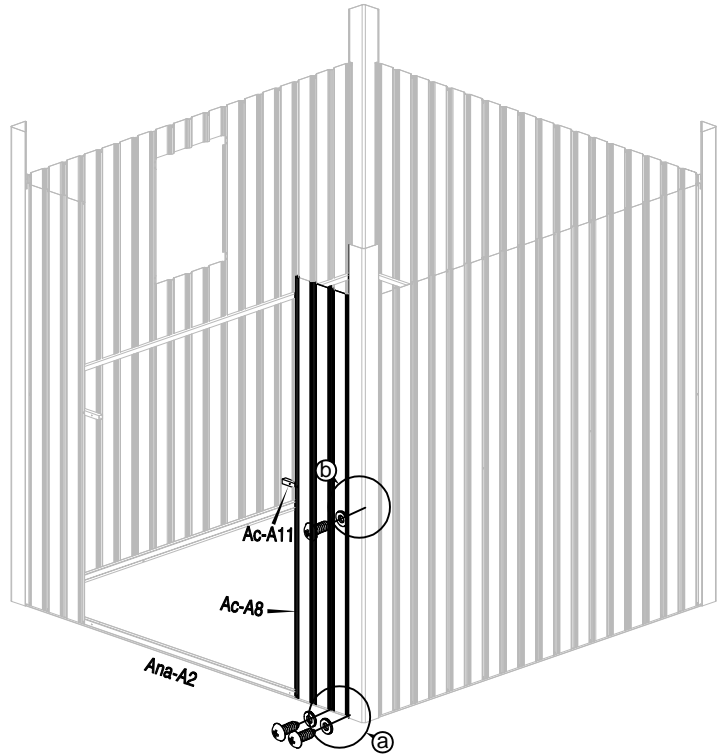
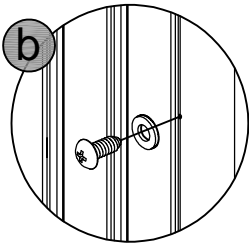
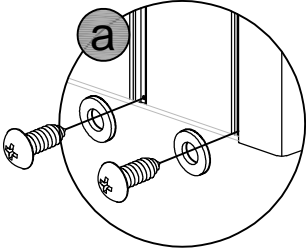

14

Ab-4 x4

Ana-B41 x12

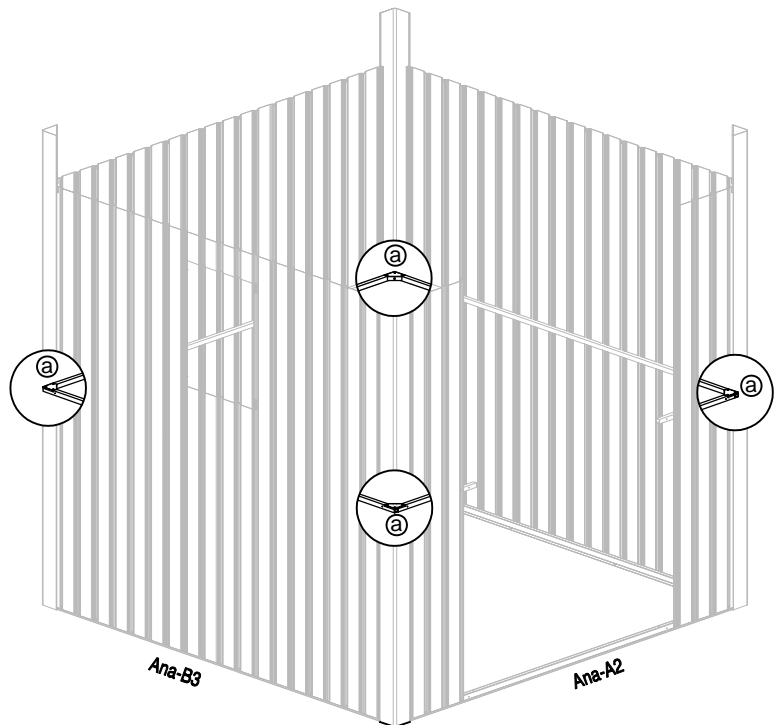
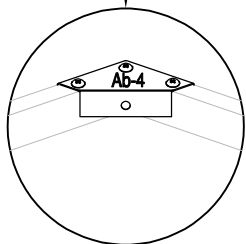
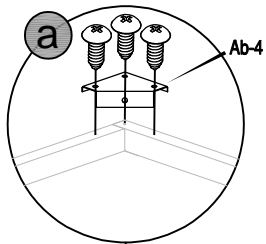

15



Ana-A4 x1



Ana-B41 x2

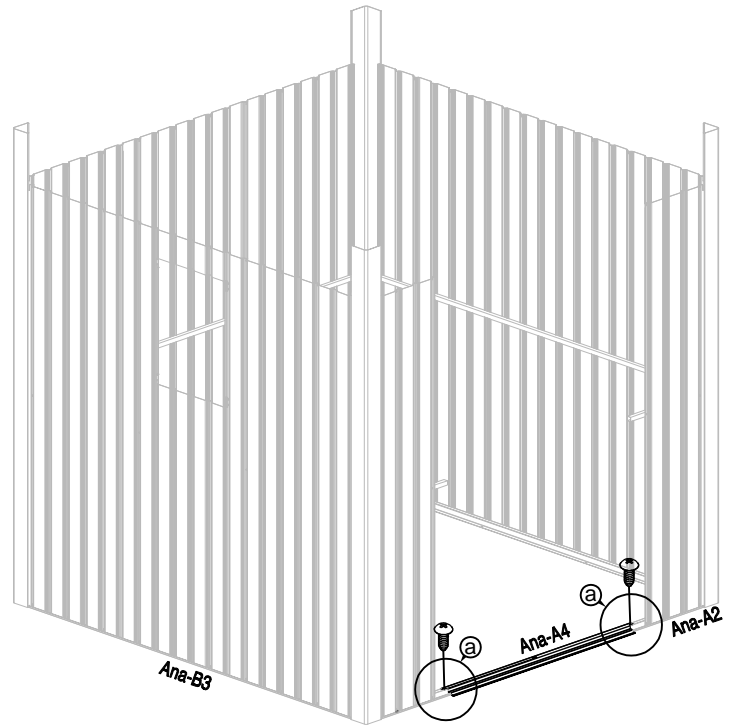
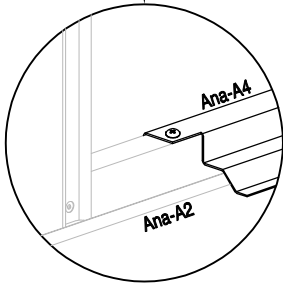
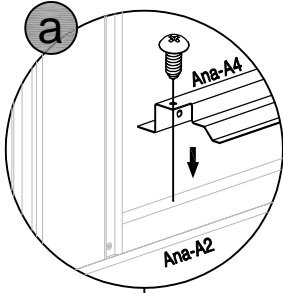
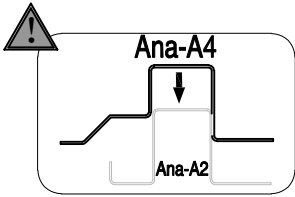

16



Ana-A16 x1



Ana-A16a x1



Ana-B41 x4



Ana-B40 x4

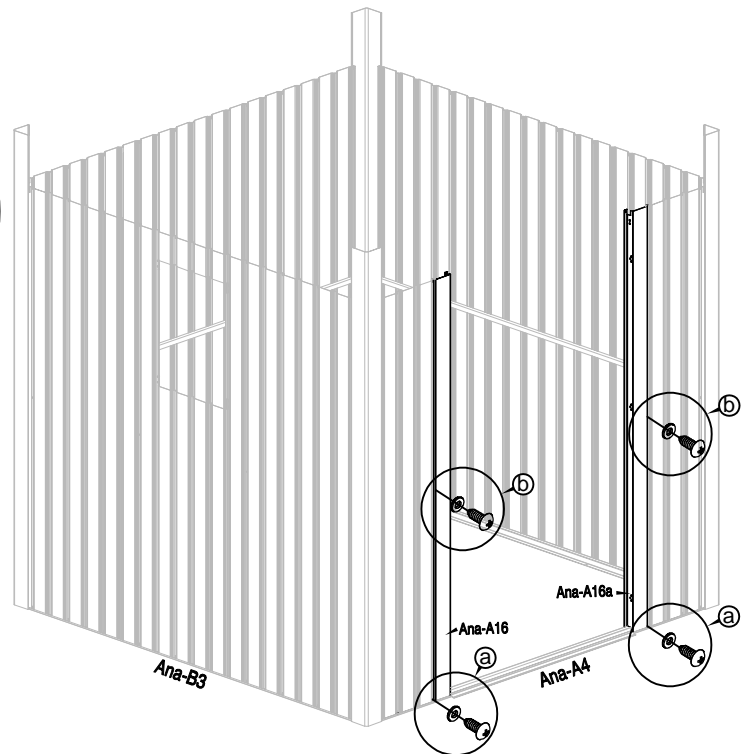
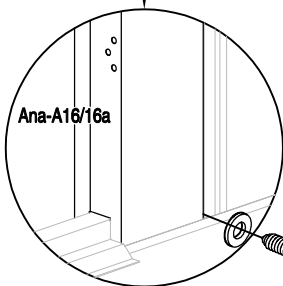
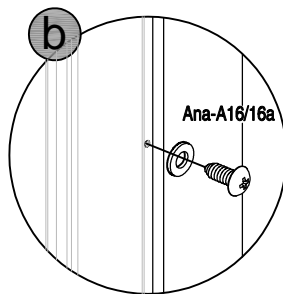
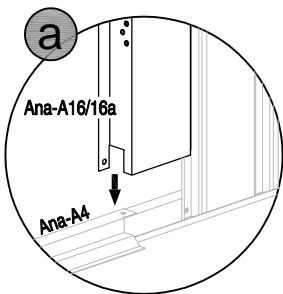

17



Ana-B41 x2

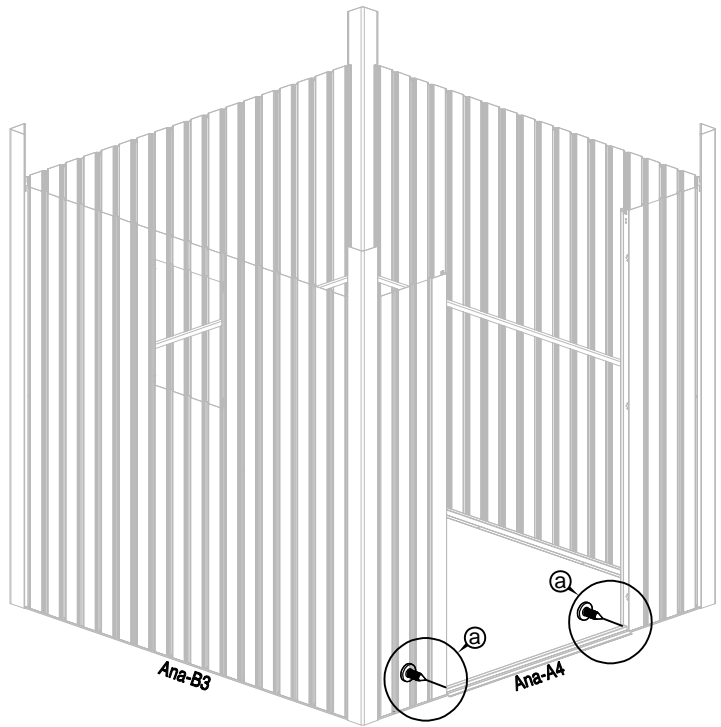
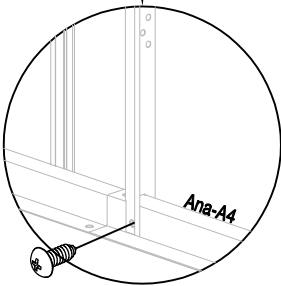
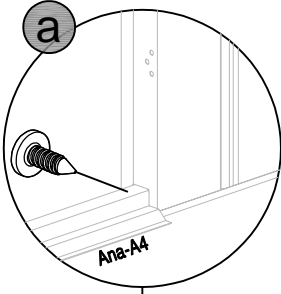

18



Ana-A13 x1



Ana-B14 x1



Ana-B41 x16



Ana-B40 x16

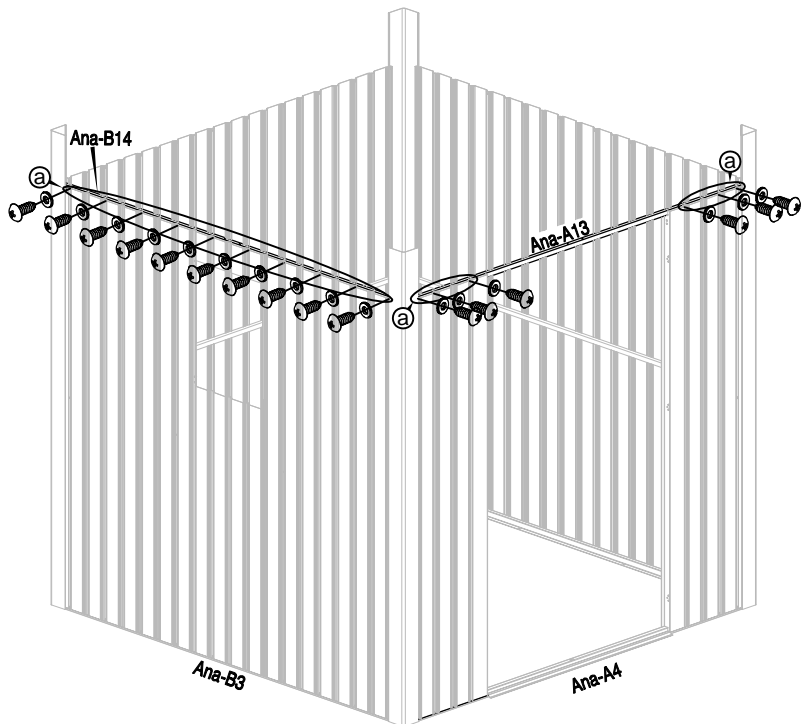
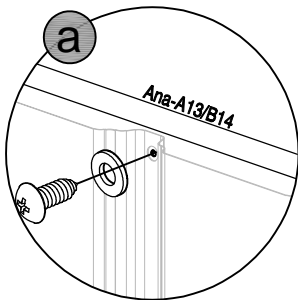
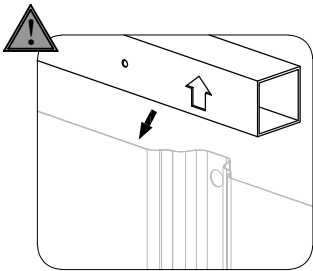

19

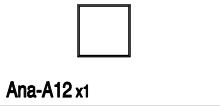

Ana-A12 x1

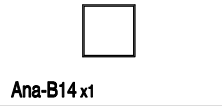

Ana-B14 x1



Ana-B41 x22



Ana-B40 x20

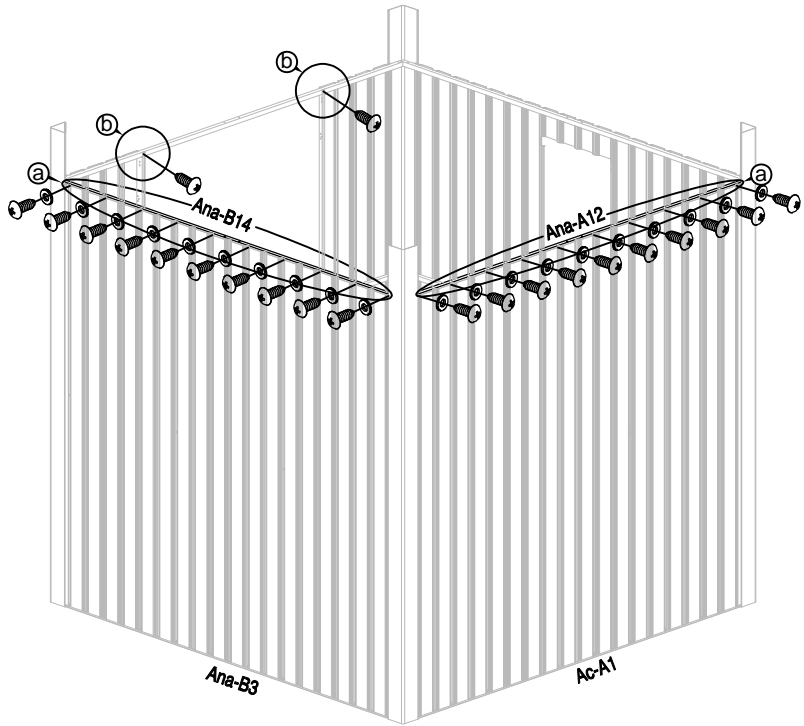
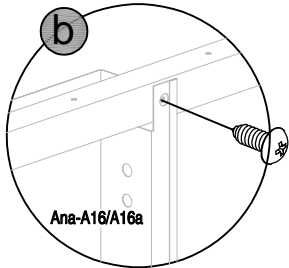
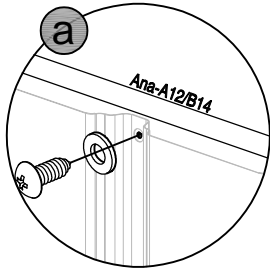
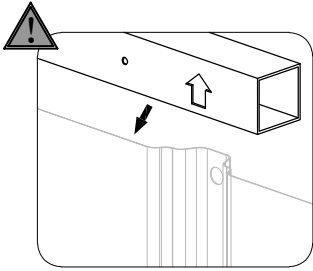

20

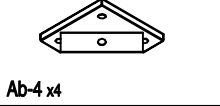

Ab-4 x4



Ana-B41 x12

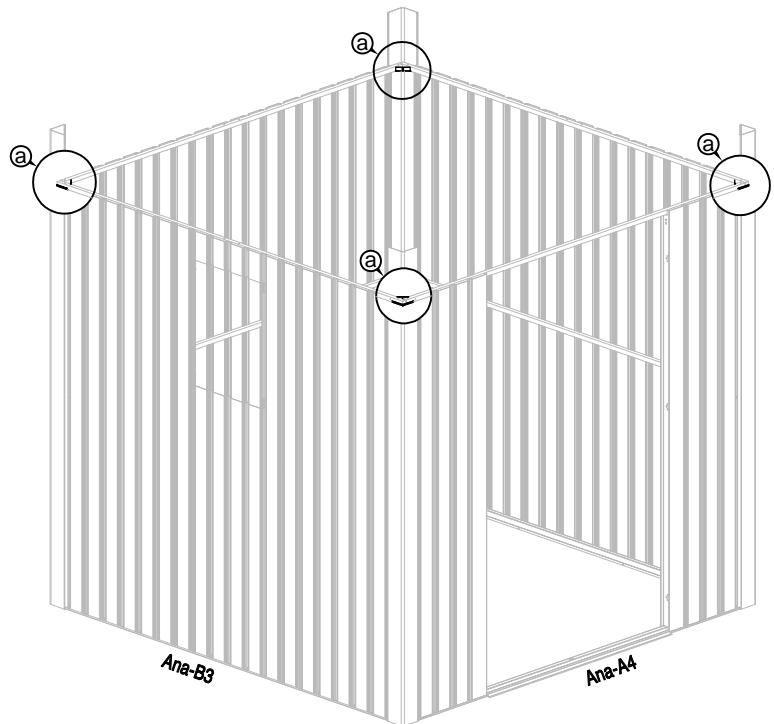
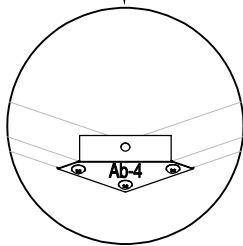
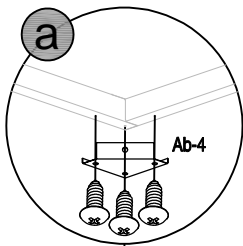

21



Ana-A17 x1



Ana-A44 x4

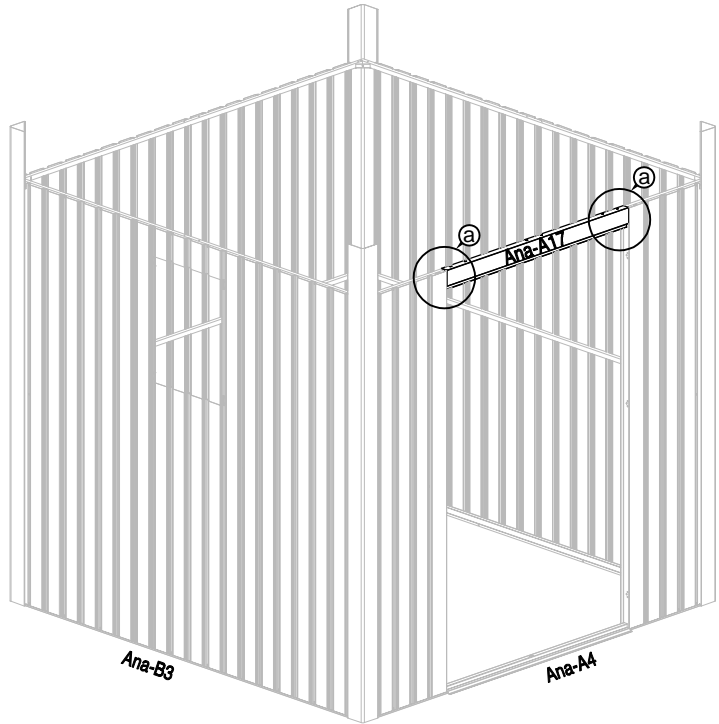
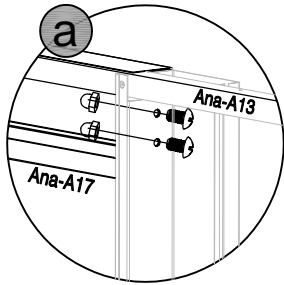
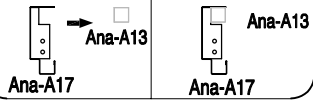

22



Ana-A18 x4

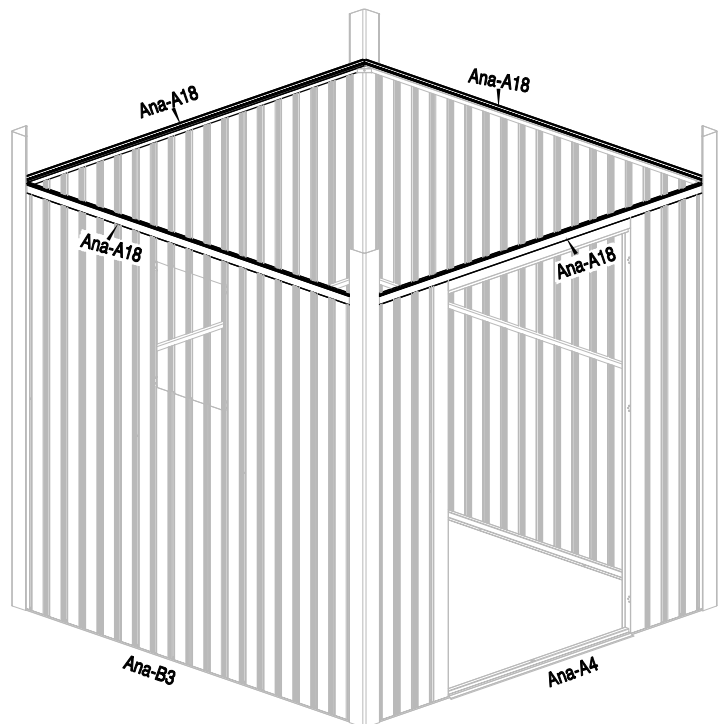
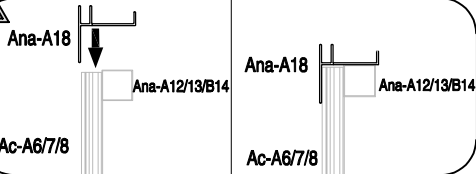

23

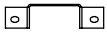

Ana-A22b x4



Ana-A22a x4



Ana-B41 x16

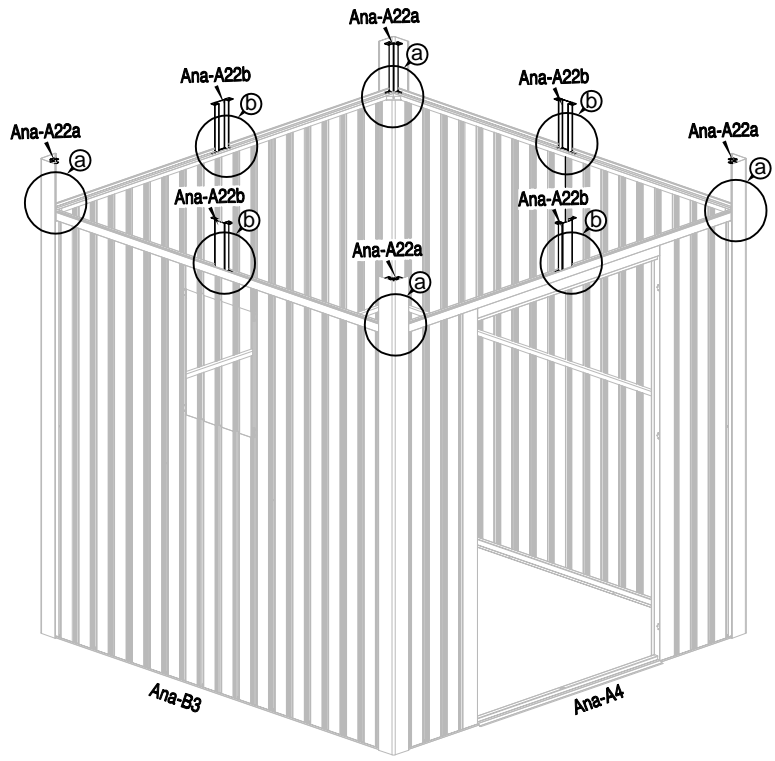
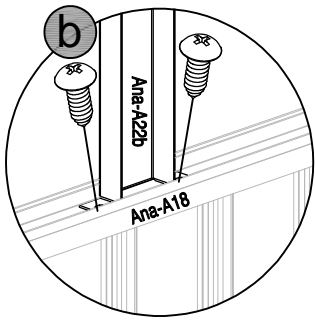
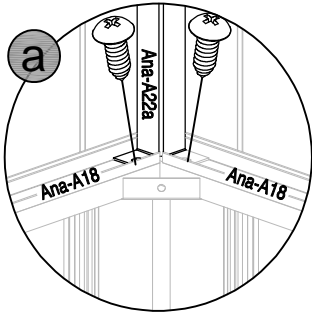

24

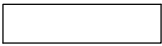

Ana-A36 x3



Ana-A38 x1

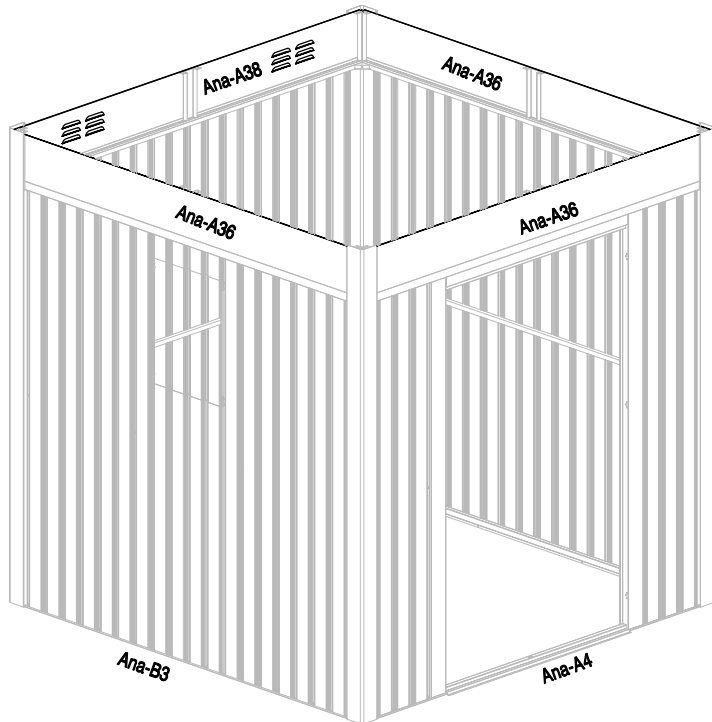
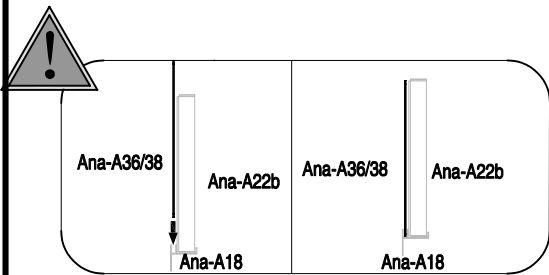
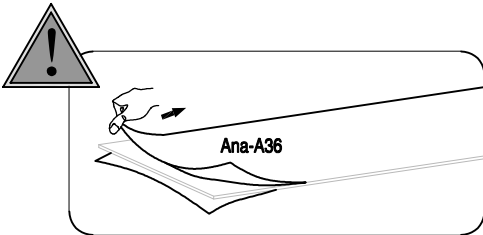

25

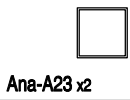

Ana-A23 x2

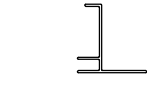

Ana-A18 x2

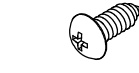

Ana-B41 x8

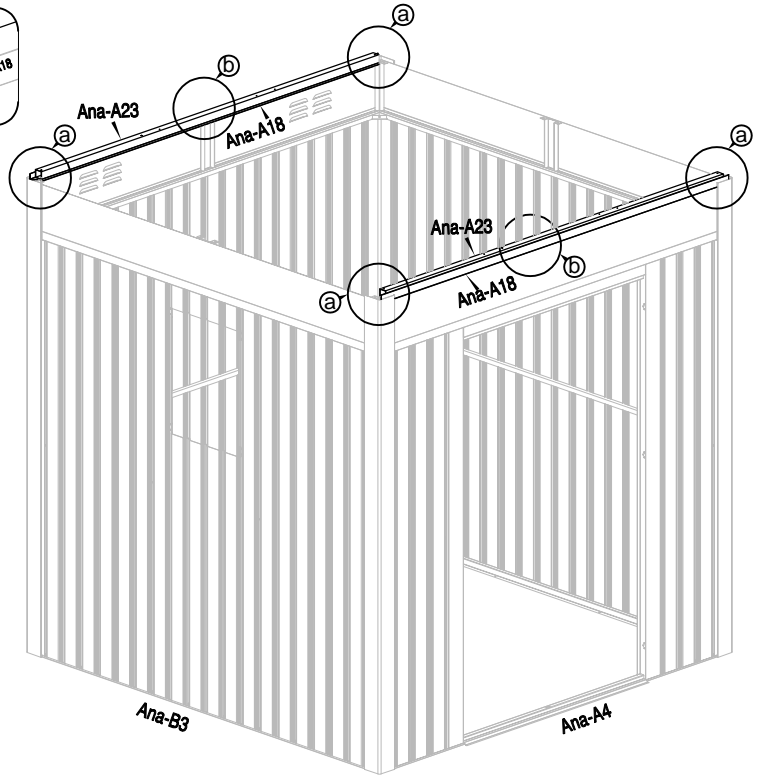
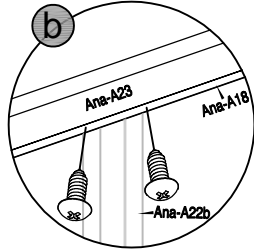
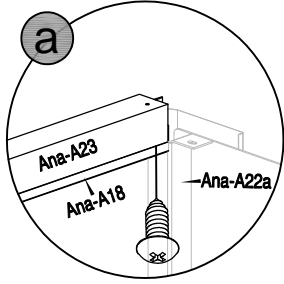
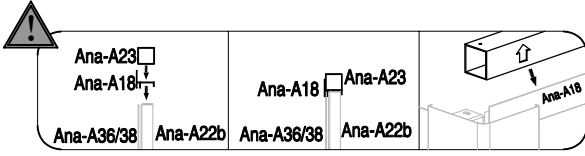

26

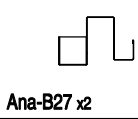

Ana-B27 x2



Ana-A18 x2



Ana-B41 x8

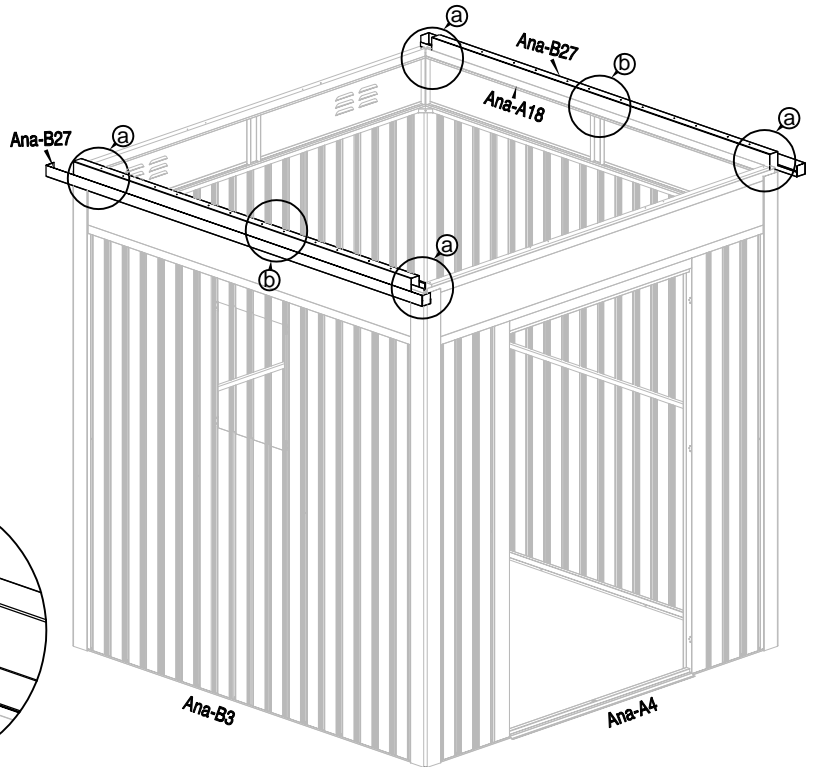
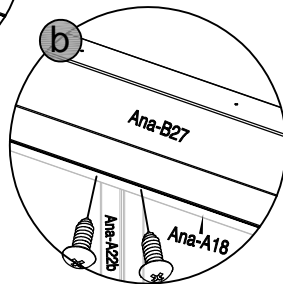
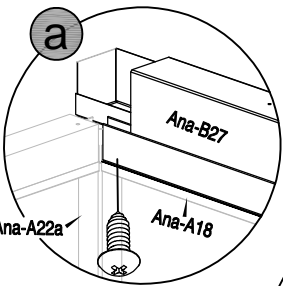
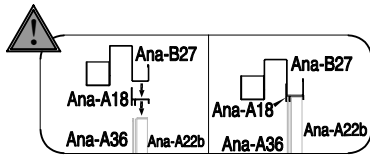

27

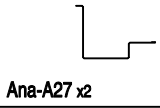

Ana-A27 x2



Ana-B41 x4

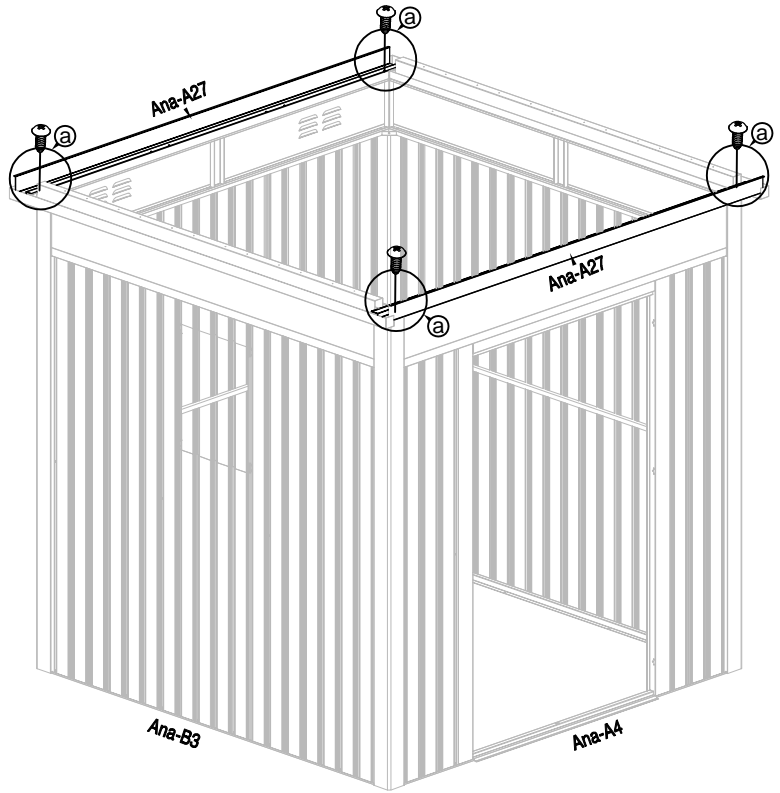
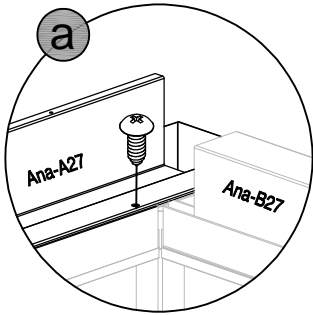

28



Ana-B26 x2



Ana-B41 x4

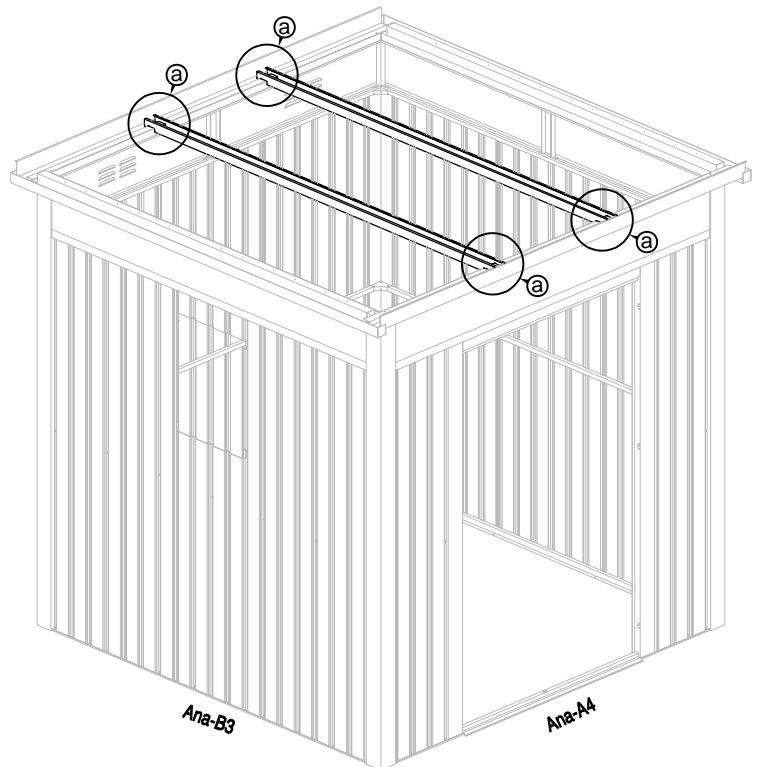
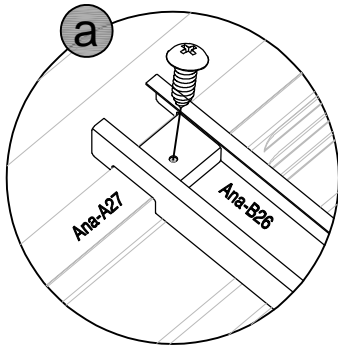

29



Ana-P1 x4

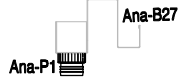
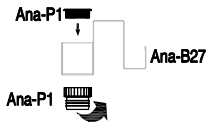

Ana-P1

Ana-P1

Ana-B3

Ana-A4

30



Ana-A25 x1



Ana-B41 x2



Ana-B40 x2

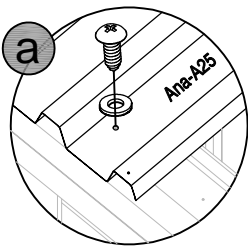

Ana-A25

Ana-B3

Ana-A4



31

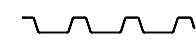

Ana-A24 x2



Ana-B41 x12



Ana-B40 x12

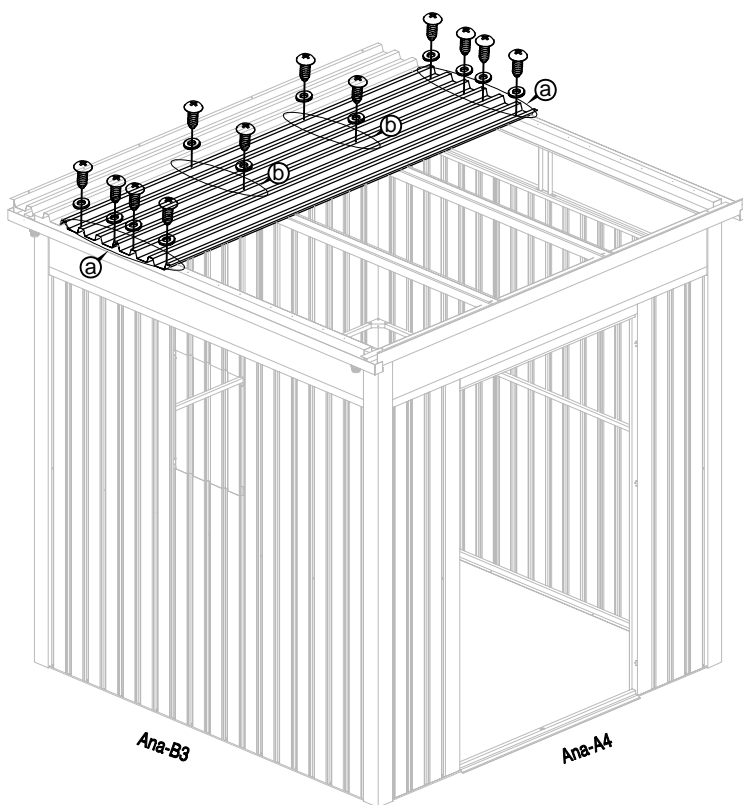
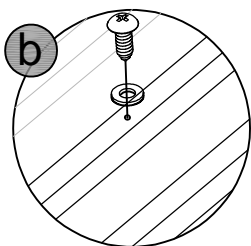
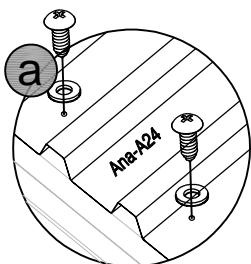
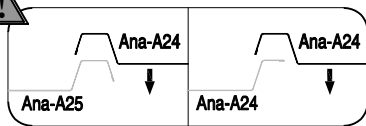

32



Ana-A24 x3



Ana-B41 x18



Ana-B40 x18

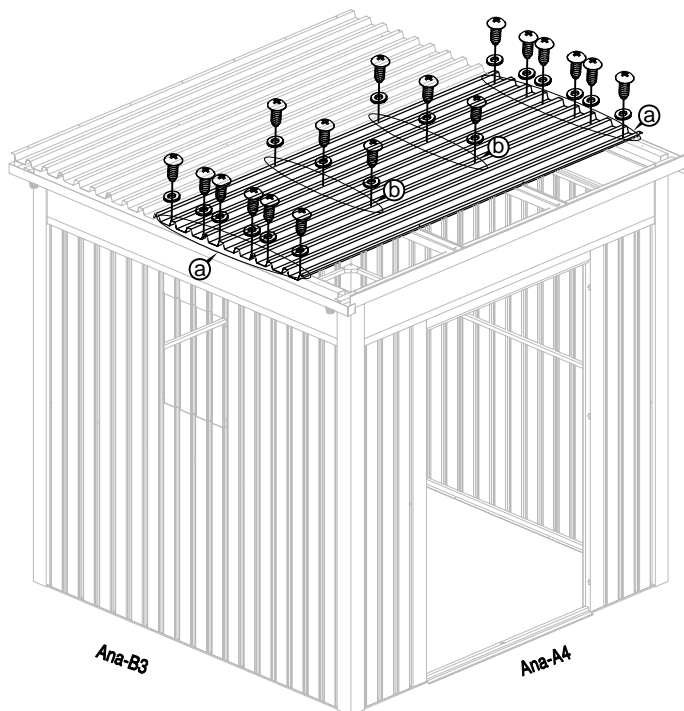
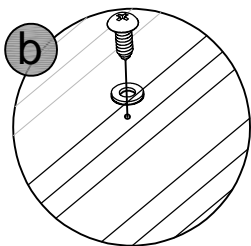
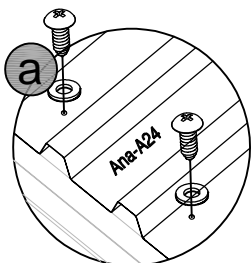
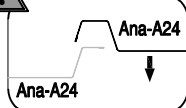

33

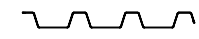

Ana-A25a x1



Ana-B41 x4



Ana-B40 x4

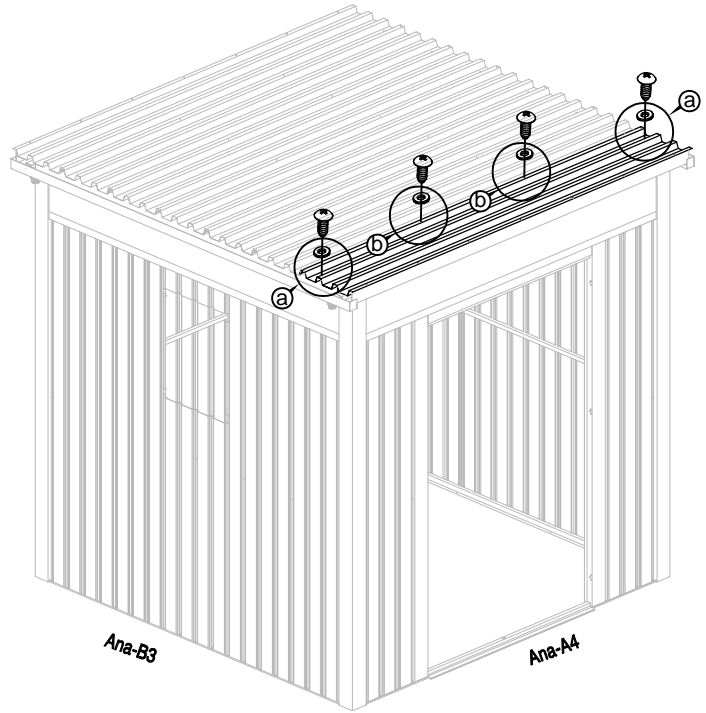
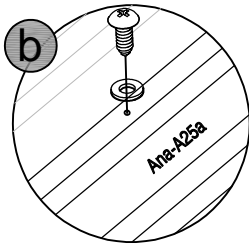
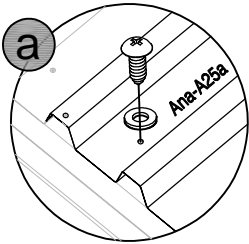
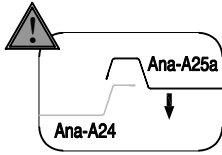

34



Ana-A28 x2



Ana-B28 x2



Ana-B41 x26



Ana-B40 x26

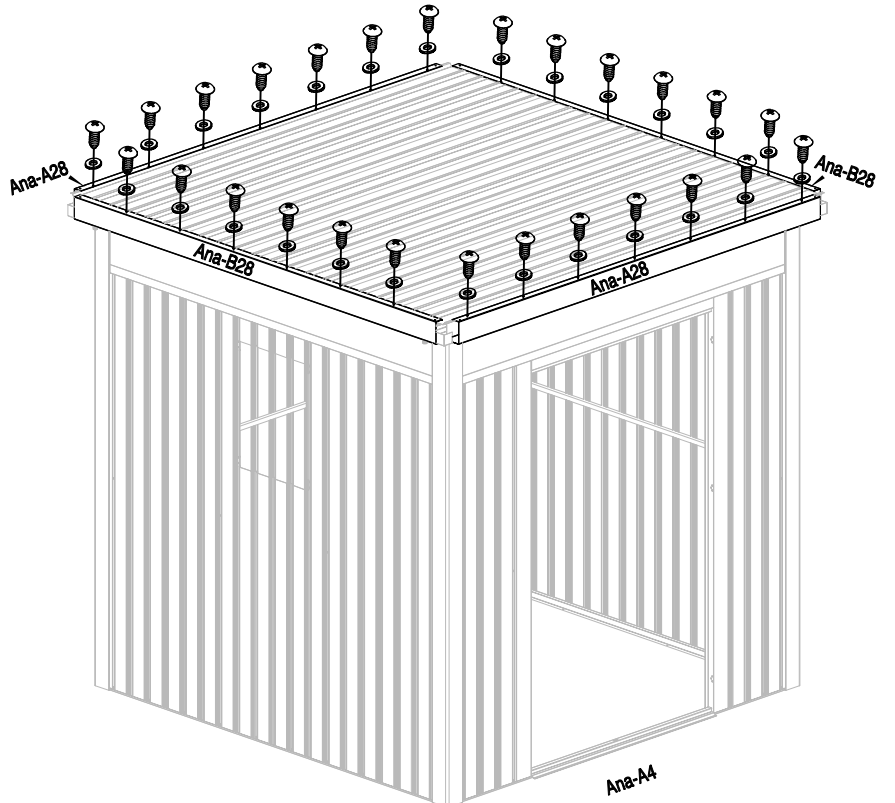
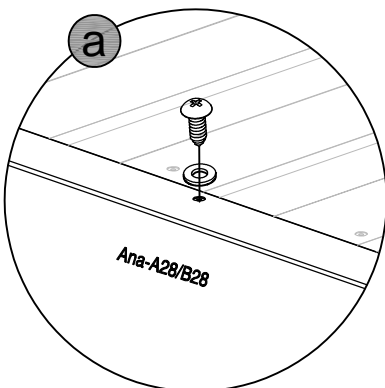

35



Ana-P2 x4



Ana-B41 x16

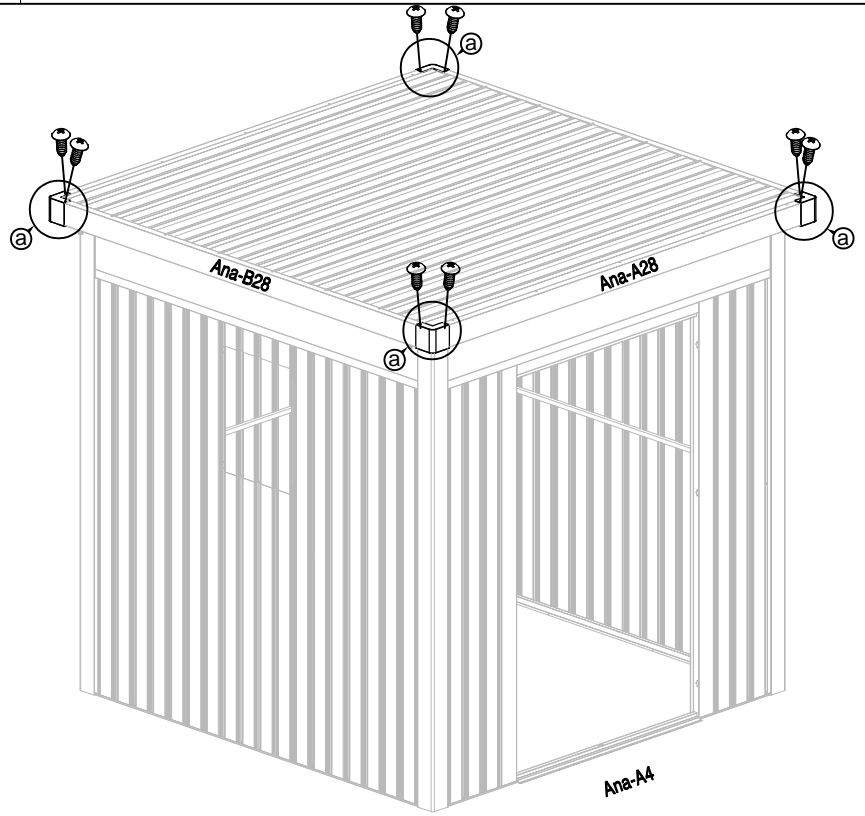
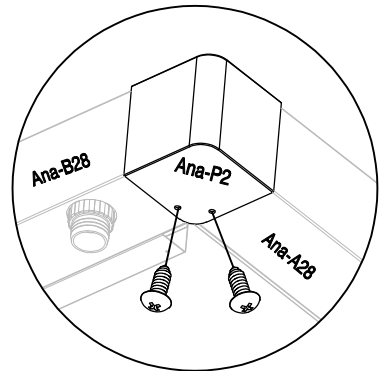
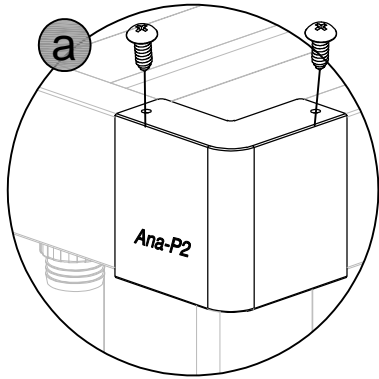

36



Ab-50 x6



Ana-A43 x18

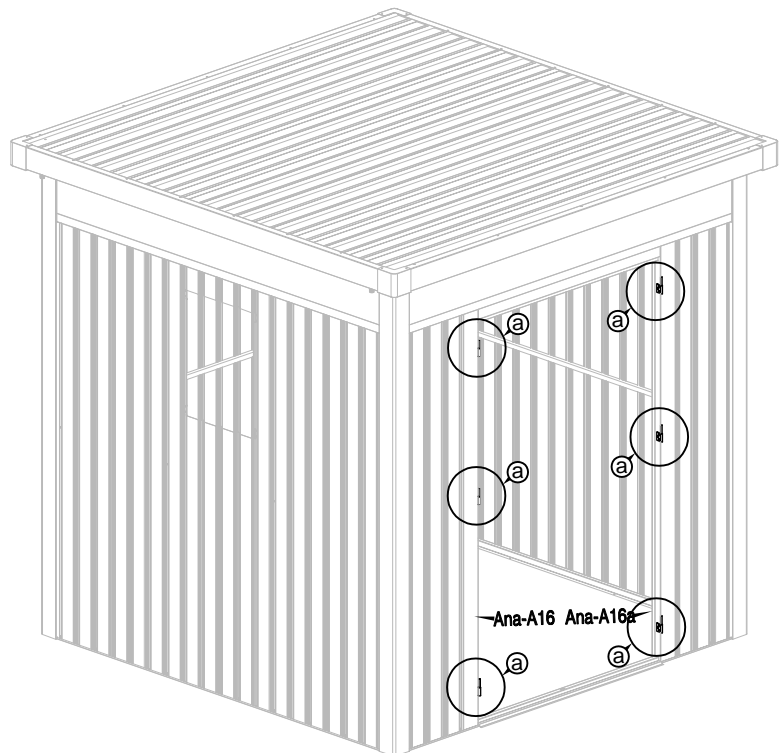
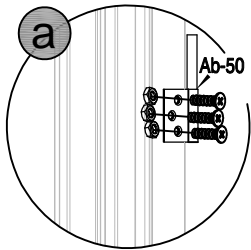

37



Ac-A29 x1



Ac-A29a x1



Ana-54 x1



Ana-55 x1



Ana-56 x1



Ana-57 x1



Ana-58 x3

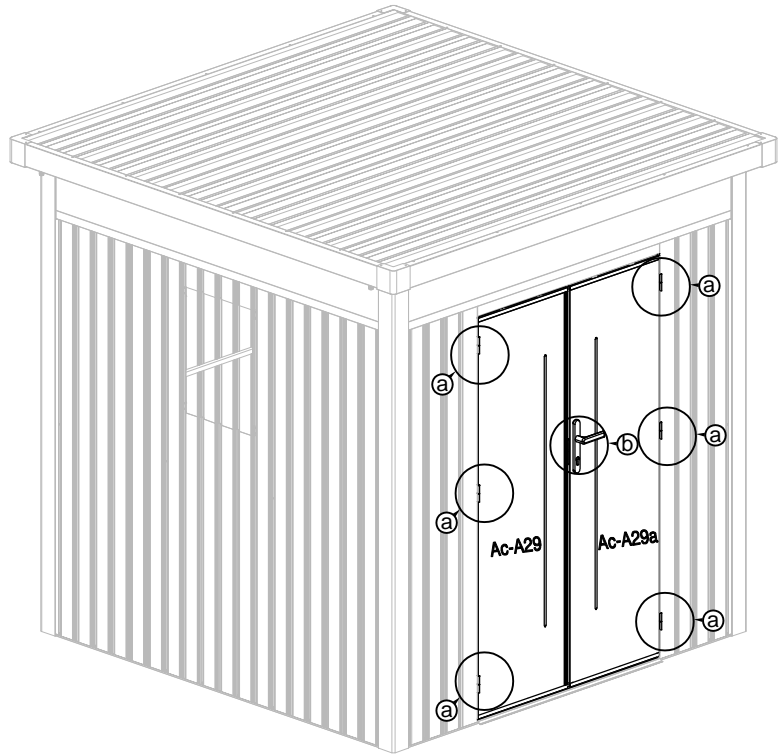
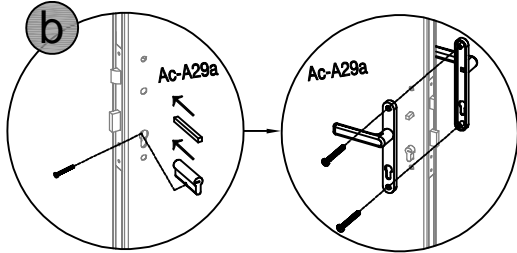
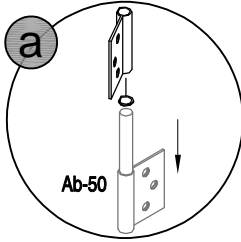

38



Ana-P6 x1



Ana-B41 x4

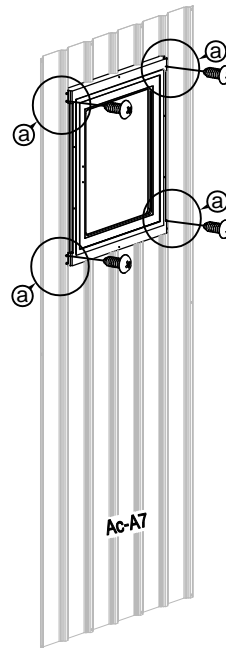
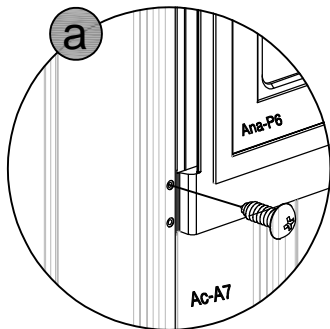
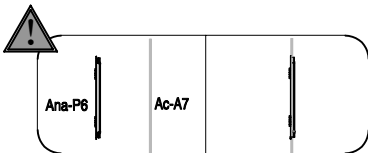

39



Ana-P7 x1



Ana-B41 x10

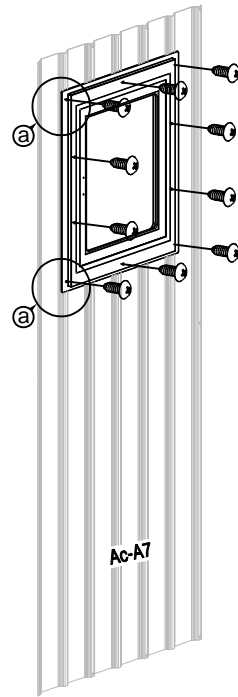
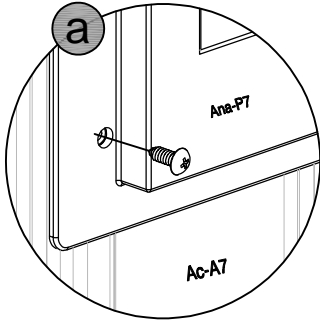
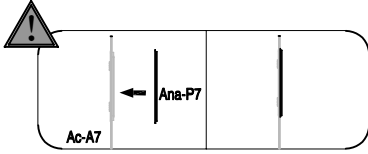

40



Ana-P8 x1



Ana-A42 x2

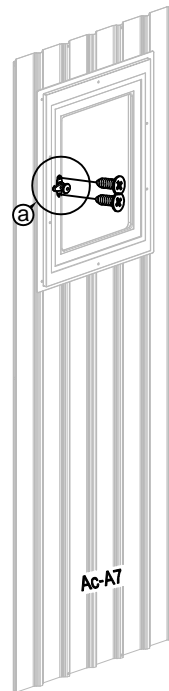
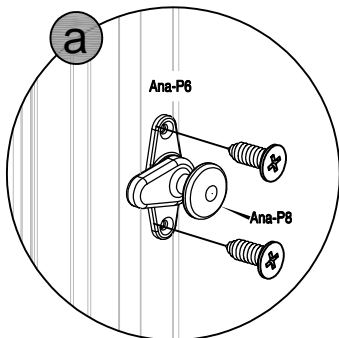

41



Ana-B37 x16.5M

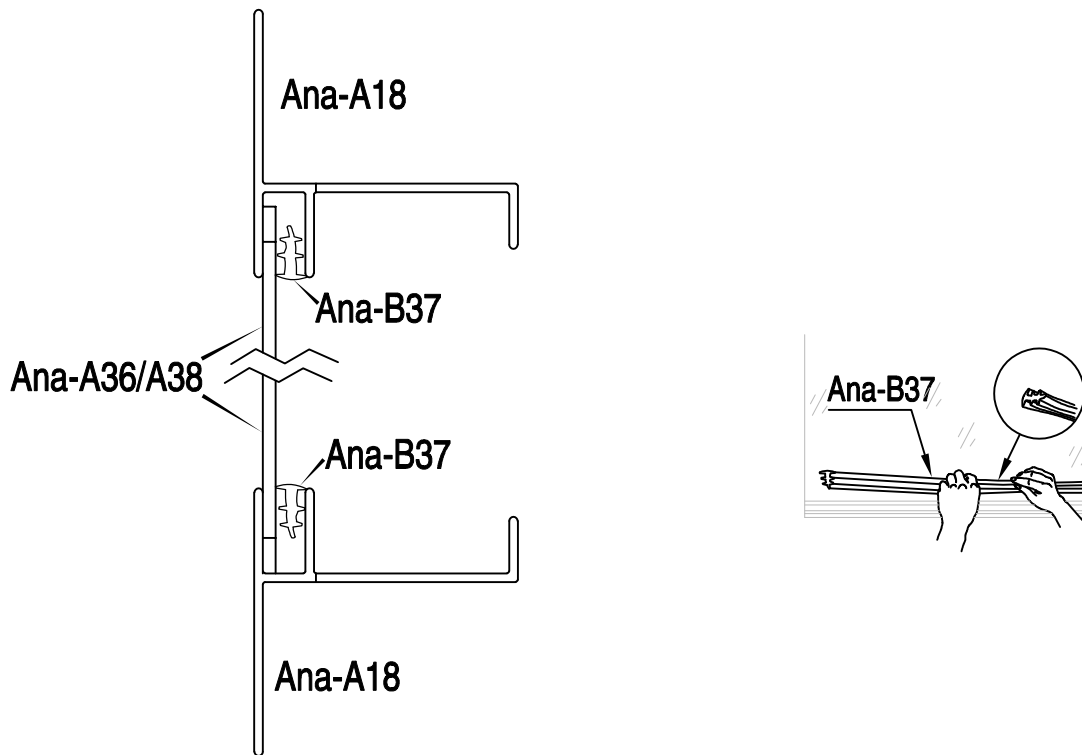

42

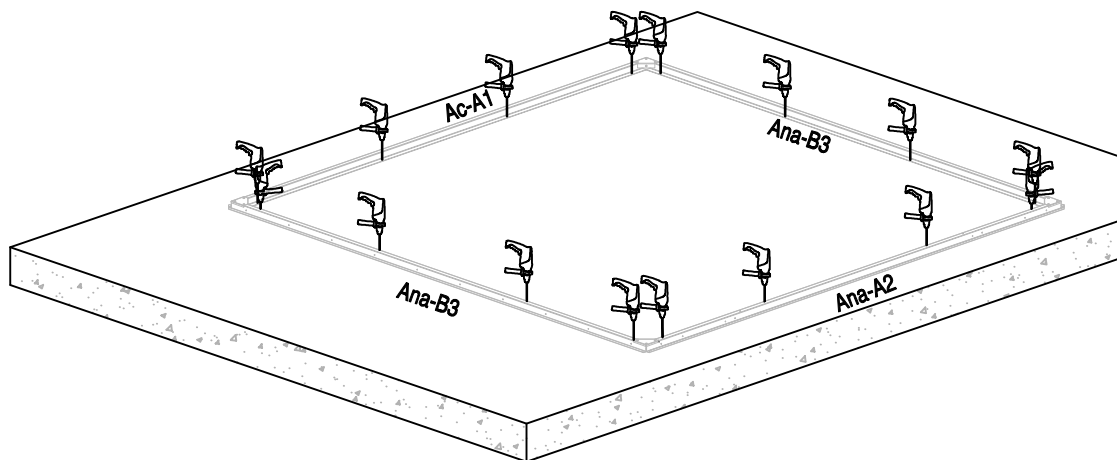
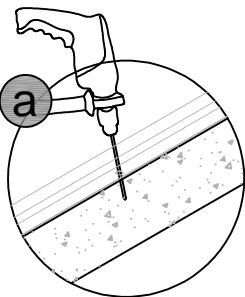
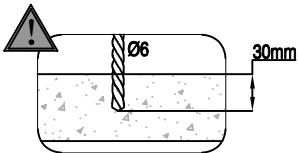
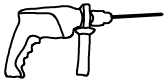

43

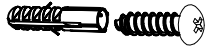

Ana-B45 x16

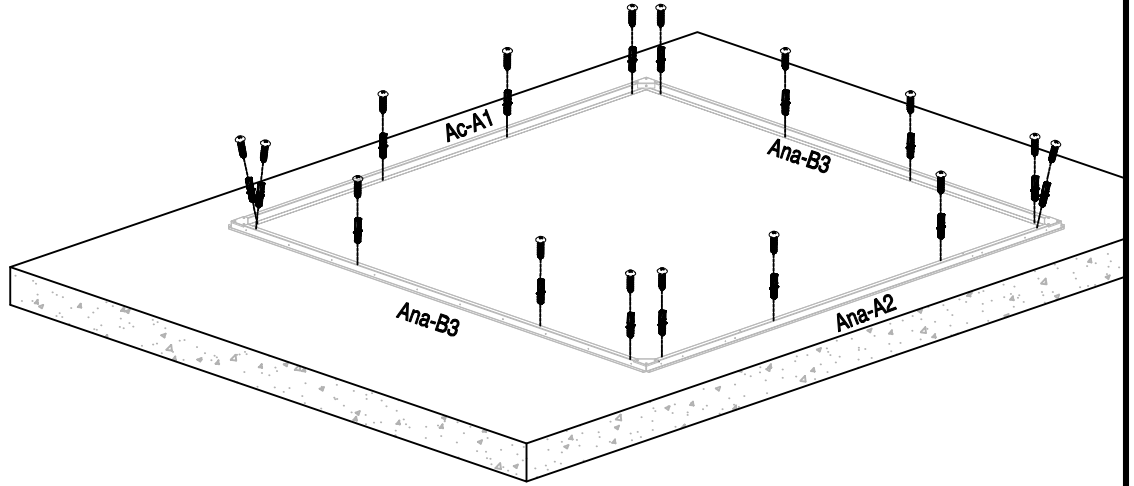
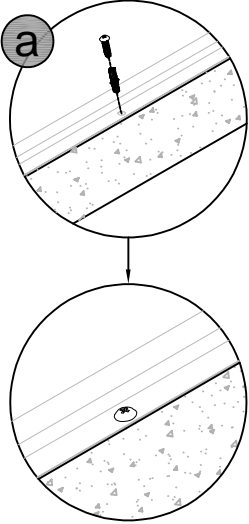



osb onlineshop-baumarkt GmbH

Adresse:
Steinbacher Straße 62
64658 Fürth
Deutschland

Tel: 0049 6253 979920
Email: service@onlineshop-baumarkt.de