

Montageanleitung Metall Anbaudach (links) M120100L / 275x230 cm
(für Gerätehaus M110100)

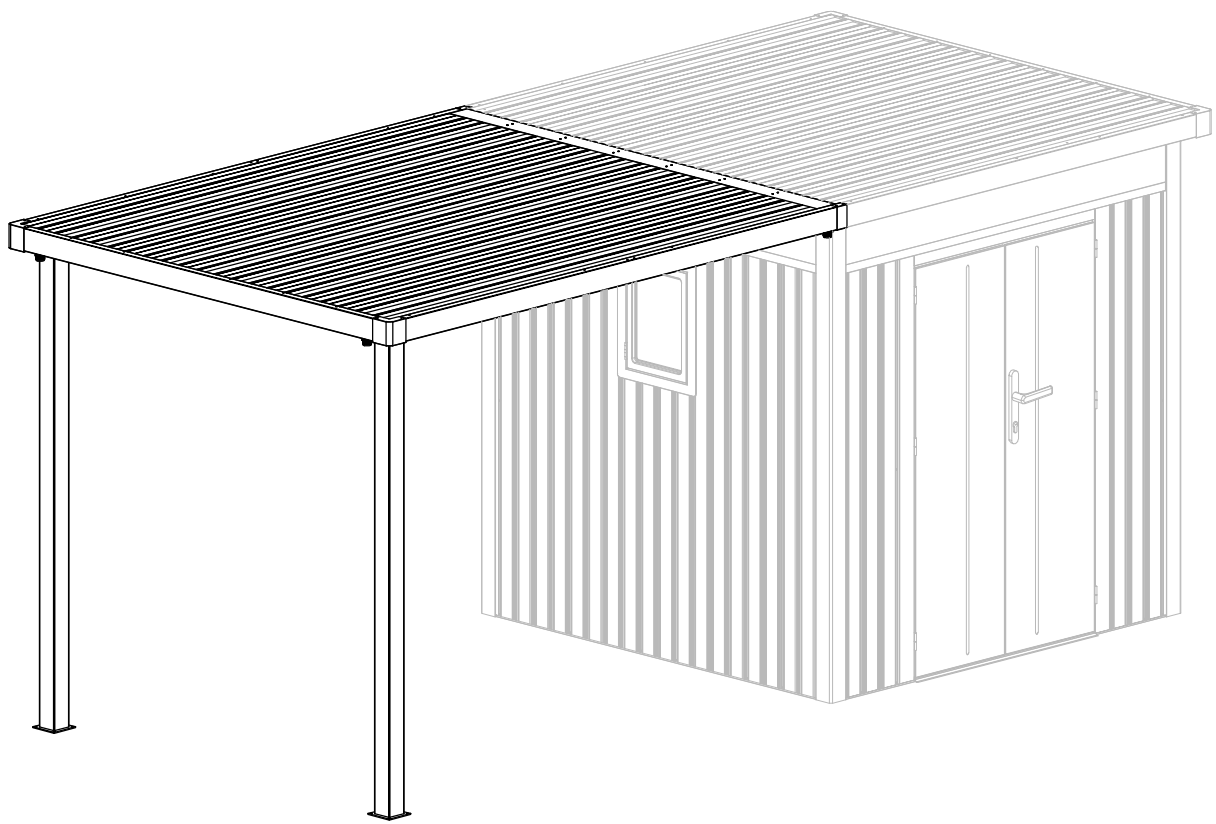

osb onlineshop-baumarkt GmbH

Website: www.onlineshop-baumarkt.de
E-mail: service@onlineshop-baumarkt.de

Erforderliche Werkzeuge & Sicherheitshinweise

Die Montage darf nur mit geeigneten Werkzeugen und unter Einhaltung der nachfolgenden Sicherheitsvorgaben durchgeführt werden. Stellen Sie bitte sicher, dass alle genannten Hilfsmittel vor Beginn der Montage vollständig vorhanden sind.

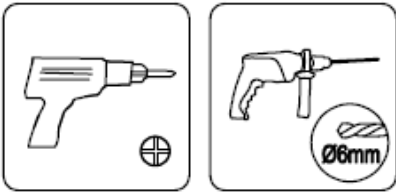

Bohrmaschine / Akkuschauber

Erforderlich ist eine Bohrmaschine bzw. ein Akkuschauber mit **Kreuzschlitz-Bit** sowie einem **6-mm-Bohrer** für Schraub- und Bohrarbeiten.

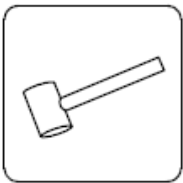

Gummihammer

Zum spannungsfreien Ausrichten und Zusammenfügen der Bauteile ohne Beschädigung der Oberflächen.

Wasserwaage

Zur waagerechten und senkrechten Ausrichtung des Metallgerätehauses. Eine korrekte Ausrichtung ist Voraussetzung für die Passgenauigkeit und Funktion der Bauteile.



Stehleiter (freistehend)

Für Montagearbeiten in der Höhe ist eine standsichere Stehleiter zu verwenden. Die Leiter muss auf einem ebenen, tragfähigen Untergrund aufgestellt werden.

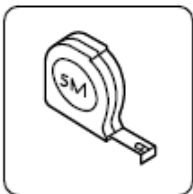

Messwerkzeug

Zur Maßkontrolle werden ein Maßband sowie ein Gliedermaßstab (Zollstock) benötigt.



Persönliche Schutzausrüstung (PSA)

Während der Montage ist geeignete persönliche Schutzausrüstung zu tragen. Dazu gehören Schutzhandschuhe, festes, geschlossenes Schuhwerk sowie lange, geschlossene Kleidung.

Bei Bohrarbeiten oder Arbeiten mit Metallteilen ist geeigneter Augenschutz (Schutzbrille) zu verwenden.

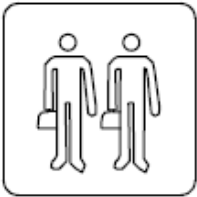

Personenanzahl

Die Montage darf nur mit mindestens zwei Personen durchgeführt werden. Beide Personen müssen körperlich belastbar sein, um Bauteile sicher zu tragen, zu positionieren und zu montieren.

Allgemeine Informationen – Metallgerätehaus

1. Kondenswasserbildung

Metall reagiert auf Temperaturunterschiede, wodurch Kondenswasser entstehen kann. Sorgen Sie für eine regelmäßige Belüftung durch Öffnen von Türen und Lüftungsöffnungen. Kondenswasser ist bei Bedarf zu entfernen. Optional kann ein Antikondensvlies an der Dachinnenseite montiert werden (nicht im Lieferumfang enthalten).

2. Dachausführung

Das Dach ist für den vorgesehenen Einsatzzweck ausgelegt. Veränderungen an der Dachkonstruktion dürfen nur gemäß Herstellerangaben erfolgen. Der Aufbau darf erst nach vollständiger Fertigstellung des Fundaments erfolgen.

3. Fundamenterstellung

Das Metallgerätehaus darf nur auf einem tragfähigen, ebenen Fundament montiert werden. Die Fundamenterstellung muss gemäß beiliegendem Fundamentplan erfolgen. Abweichungen können zu Funktionsstörungen und zum Verlust von Gewährleistungsansprüchen führen.

4. Gebrauchsspuren

Während der Montage und Nutzung können oberflächliche Kratzer oder Druckstellen entstehen. Diese sind material- und nutzungsbedingt und stellen keinen Mangel dar. Bauteile dürfen nicht gezogen, nicht auf harten Untergründen abgelegt und nicht mit spitzen oder scharfkantigen Gegenständen in Kontakt gebracht werden.

5. Wartung und Pflege

Das Metallgerätehaus ist wartungsarm. Reinigen Sie es regelmäßig mit milden Reinigungsmitteln und weichen Tüchern. Scheuernde oder aggressive Reinigungsmittel sind zu vermeiden.

6. Sturmsicherung

Das Gerätehaus muss fachgerecht am Fundament verankert werden. Je nach Standort kann eine zusätzliche Sturmsicherung erforderlich sein. Diese ist in der Regel nicht im Lieferumfang enthalten.

7. Belüftung und Nutzung

Achten Sie auf eine ausreichende Luftzirkulation, insbesondere bei der Lagerung feuchtigkeitsempfindlicher Gegenstände, um Feuchtigkeitsbildung und Korrosion zu vermeiden.

Abmessungen (L):

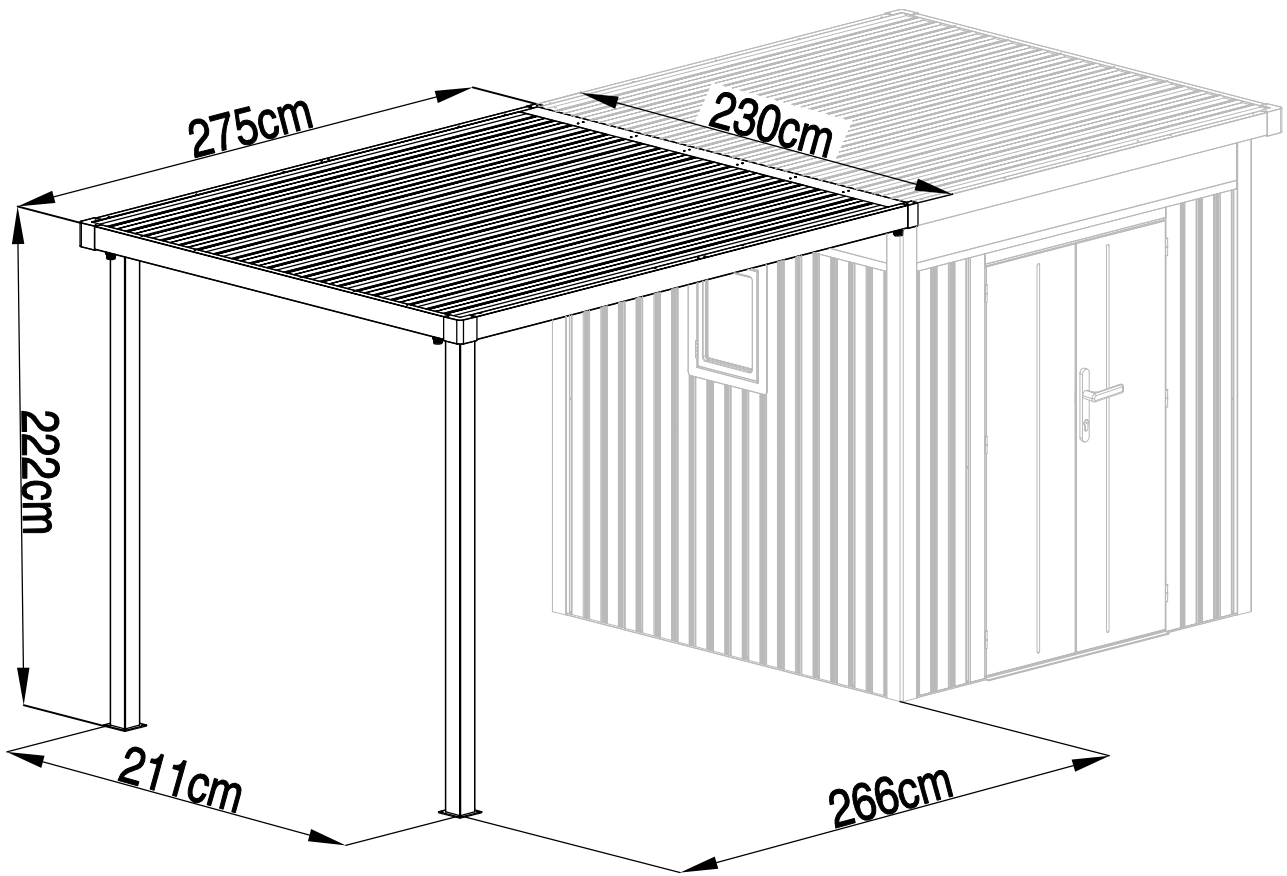

Fundamentplan:

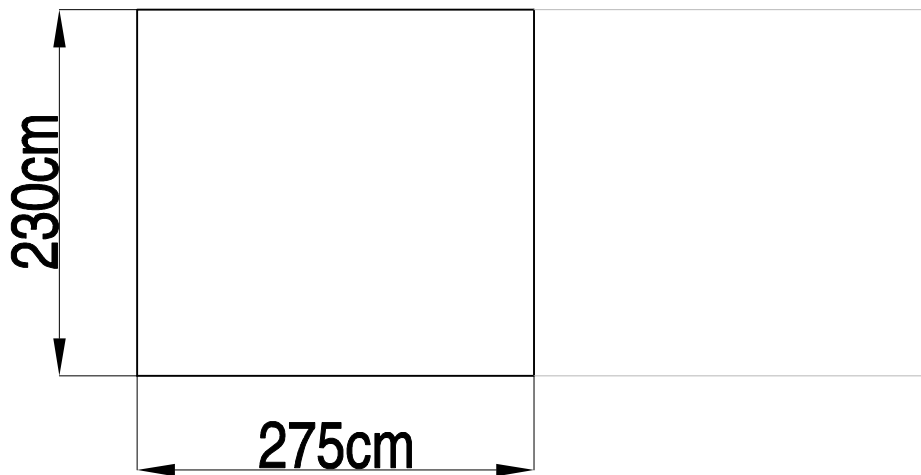

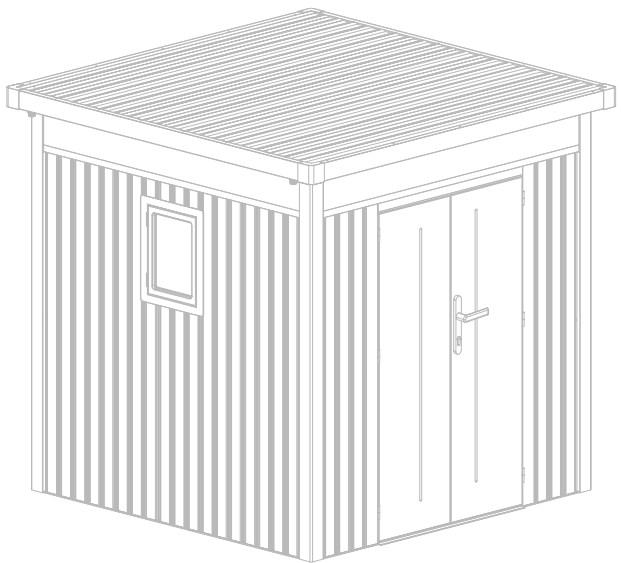
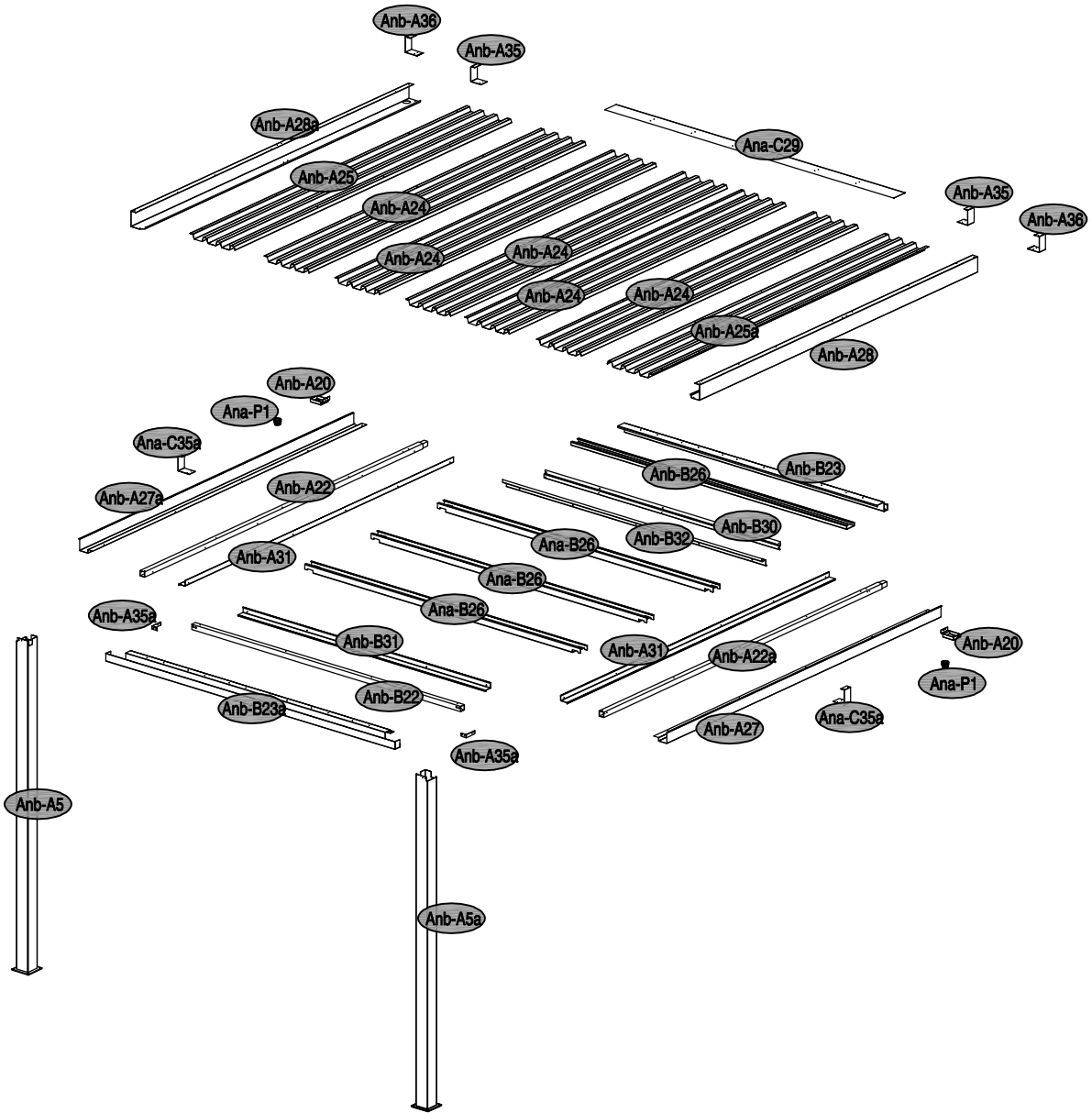

M110100

1



HANDLE WITH CARE

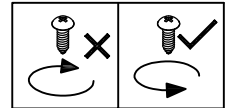
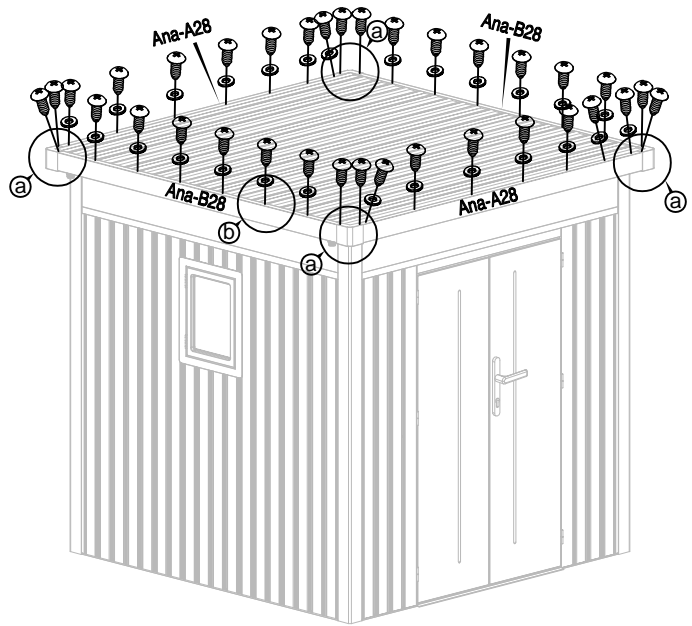
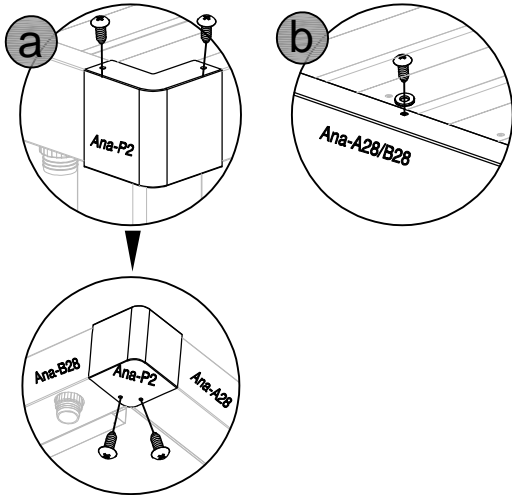

2



HANDLE WITH CARE

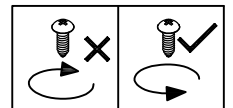
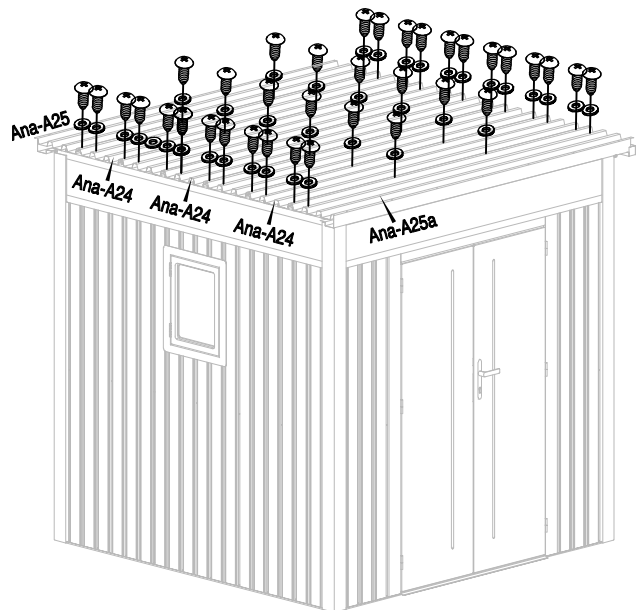
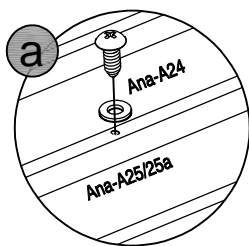

3

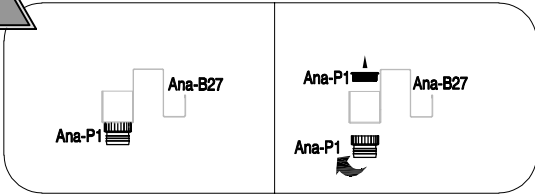

HANDLE WITH CARE

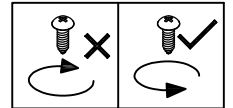
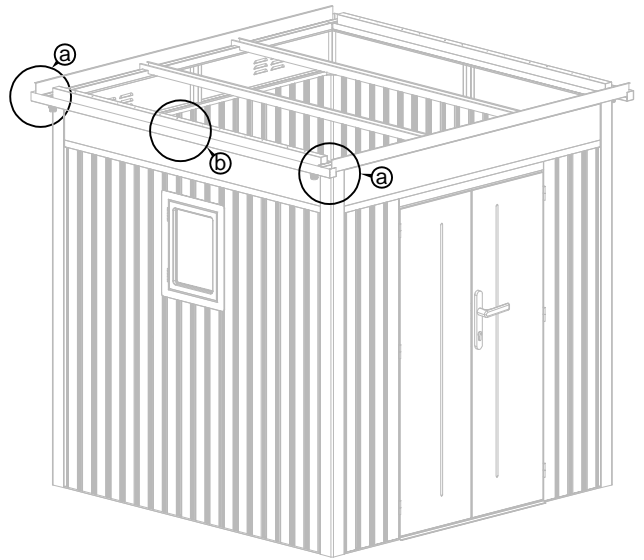
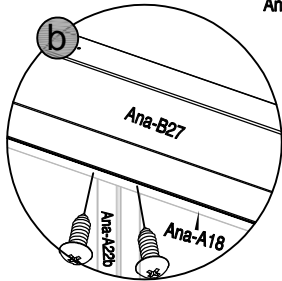
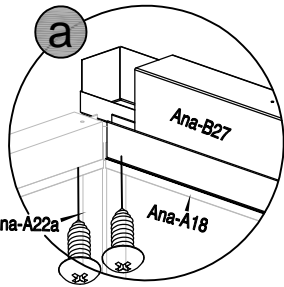

4



HANDLE WITH CARE

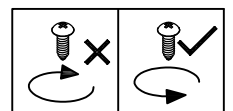
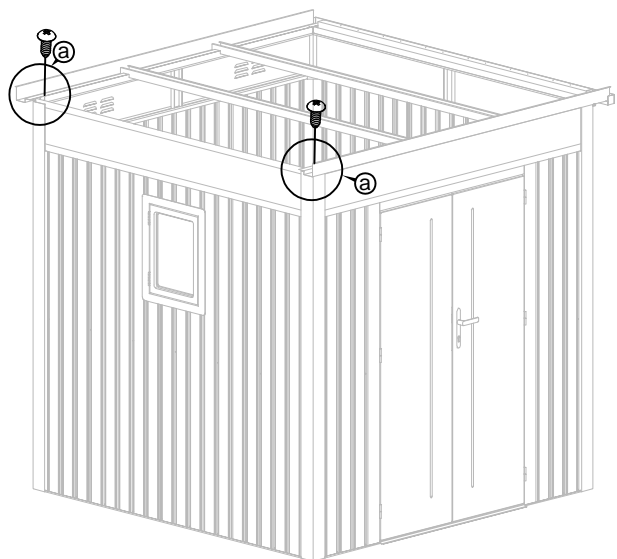
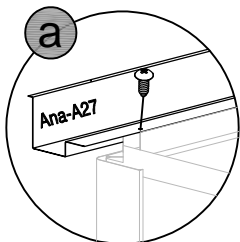

5



Anb-A5 [x1]



Anb-A5a [x1]



Anb-A22 [x1]



Anb-A22a [x1]



AnbX-C43 [x4]

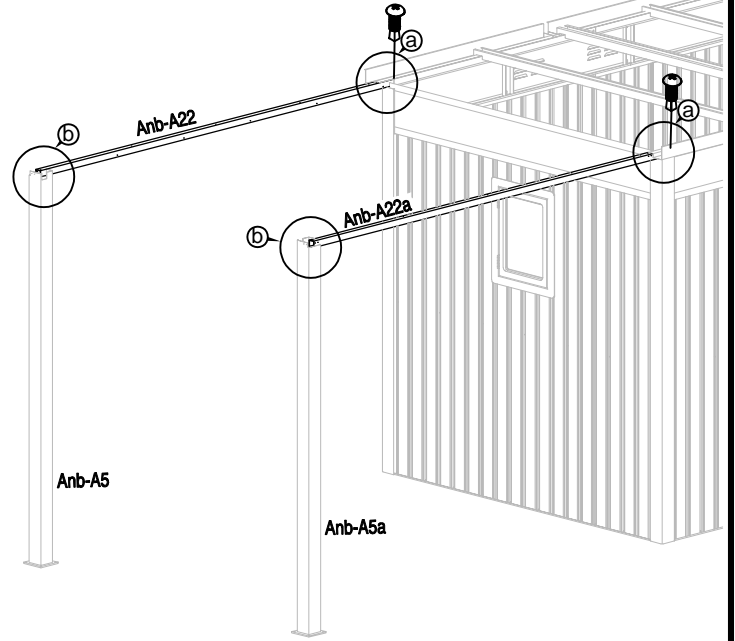
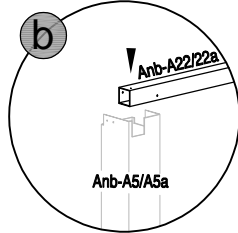
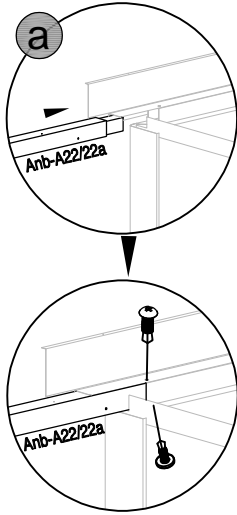

6



Anb-B22 [x1]



Anb-A35a [x2]

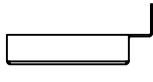

Anb-A20 [x2]



Ana-P1 [x2]



AnbX-C41 [x12]

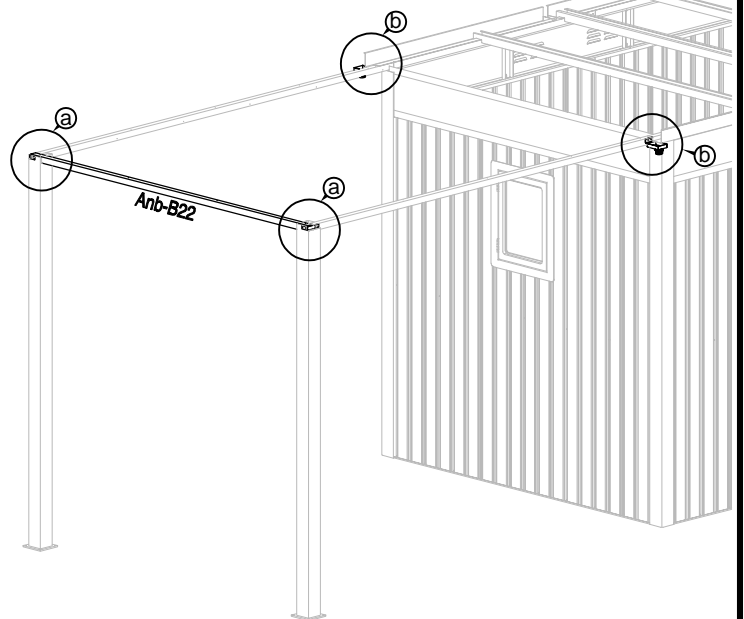
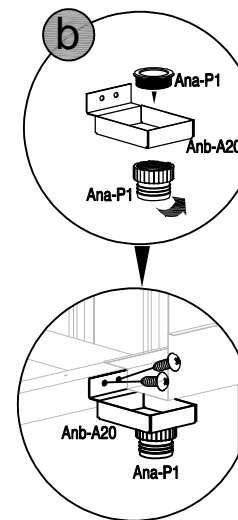
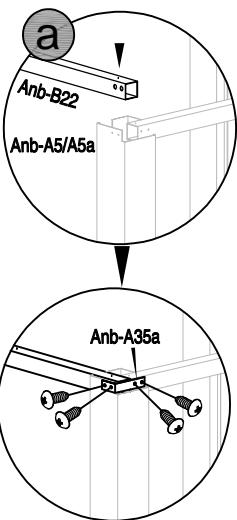

7



Anb-A27 [x1]



Anb-A27a [x1]



AnbX-C41 [x4]

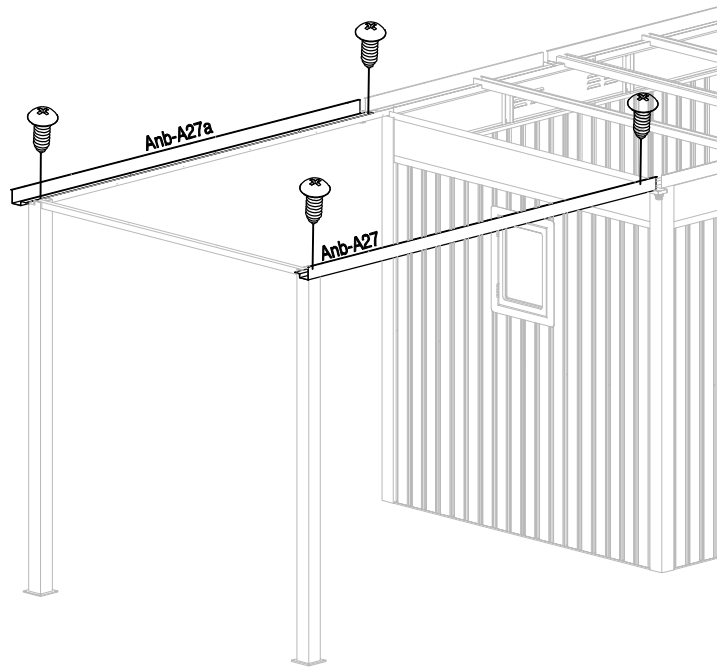
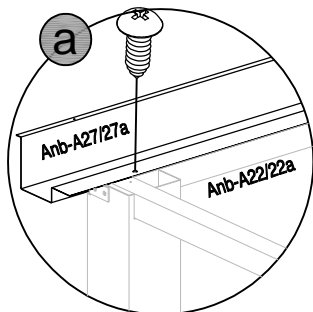

8



Anb-B26 [x1]



AnbX-C41 [x2]



AnbX-C40 [x2]

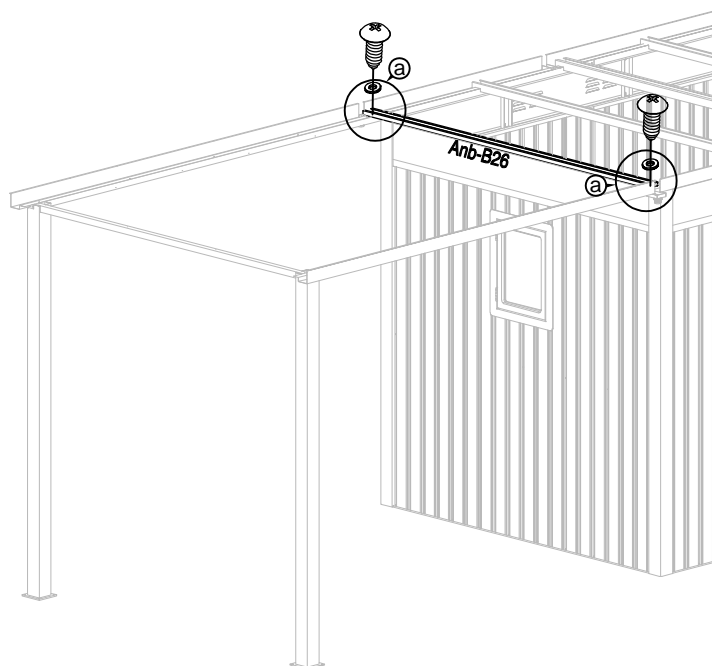
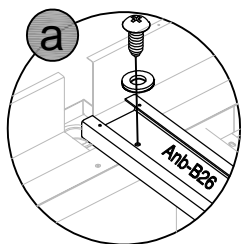

9

Anb-B30 [x1]

Anb-B23 [x1]

AnbX-C41 [x5]

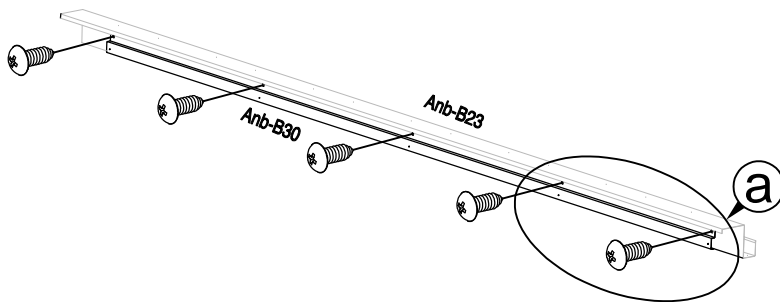
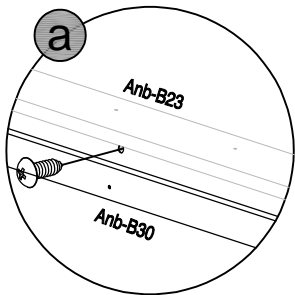
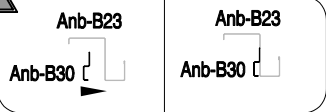

10

AnbX-C41 [x4]

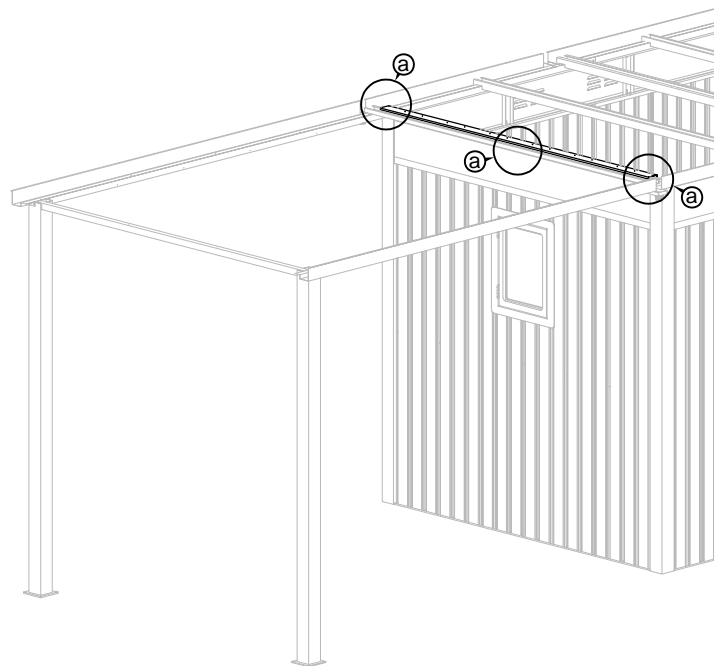
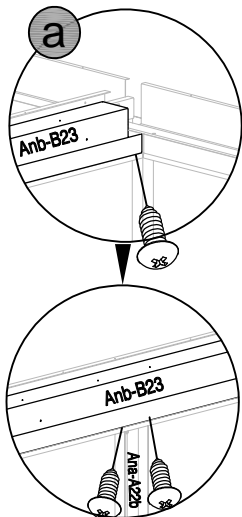
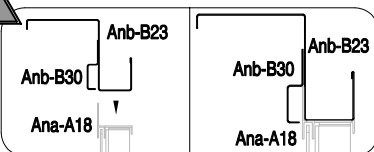

11

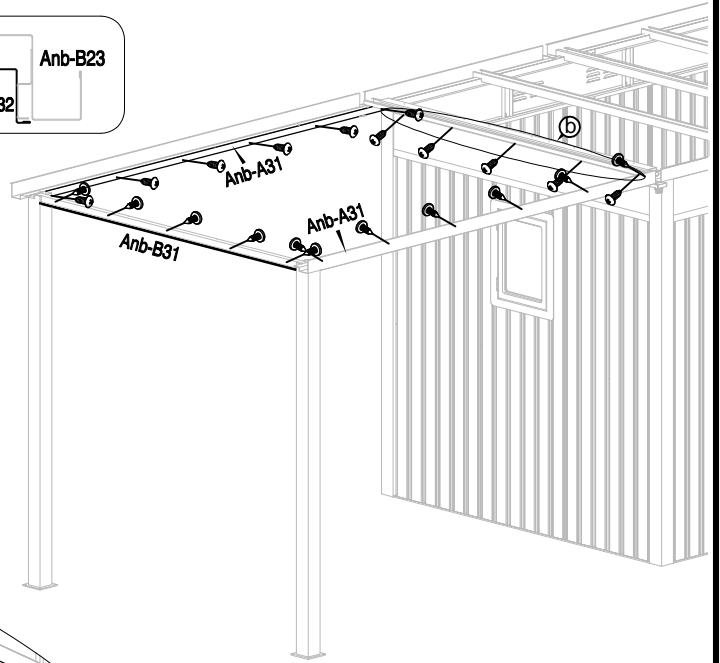
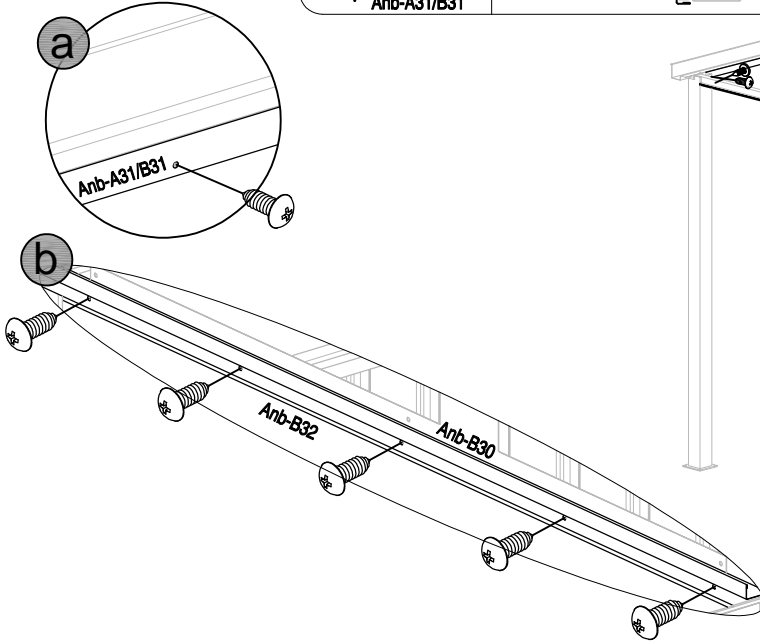
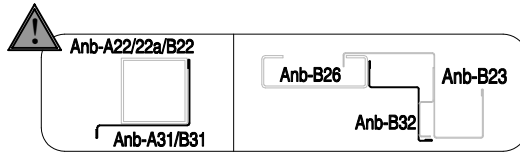
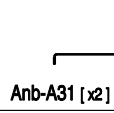
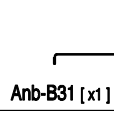
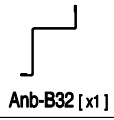

12

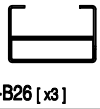

Ana-B26 [x3]

AnbX-C41 [x6]

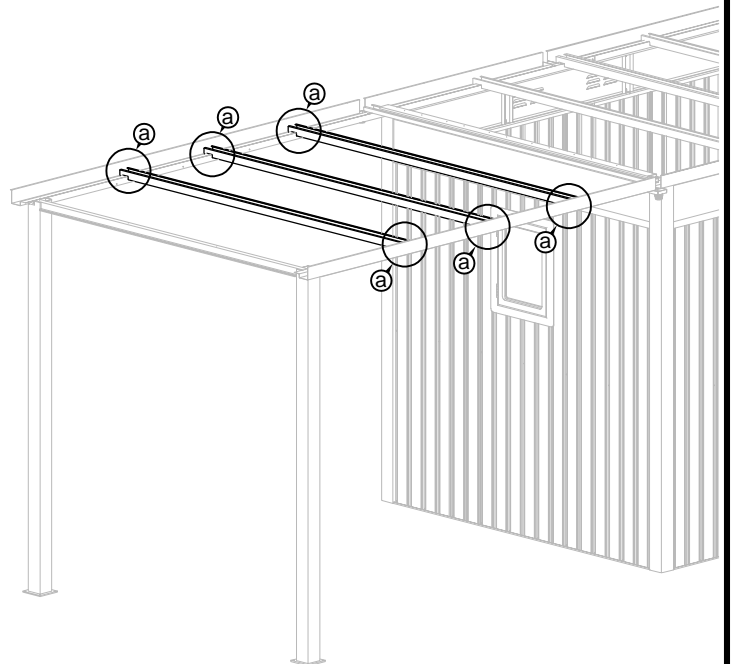
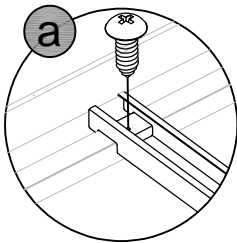

13

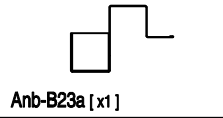

Anb-B23a [x1]



Ana-P1 [x2]



AnbX-C41 [x4]

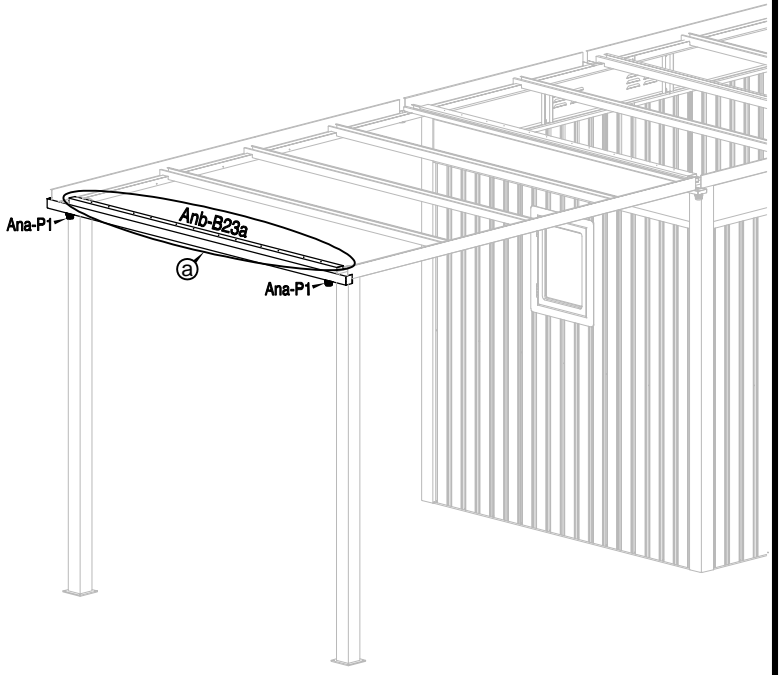
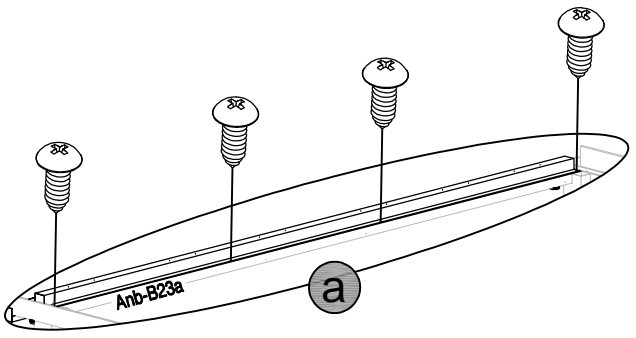
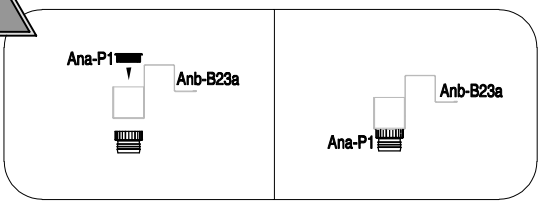

14



Anb-A25 [x1]



Ana-A25 [x1]



AnbX-C41 [x4]



AnbX-C40 [x4]

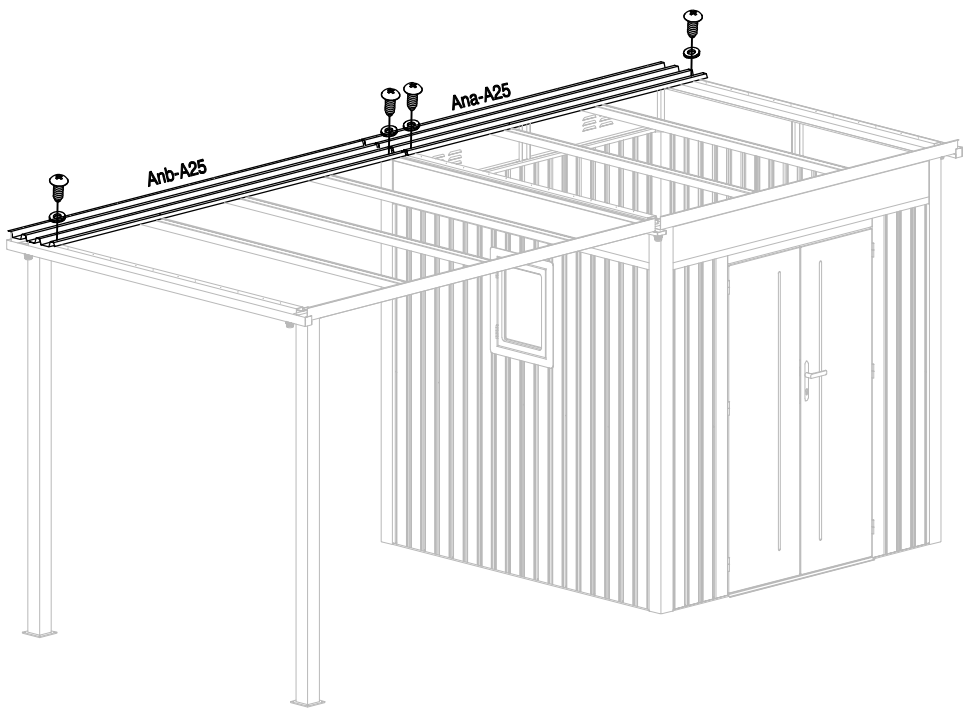
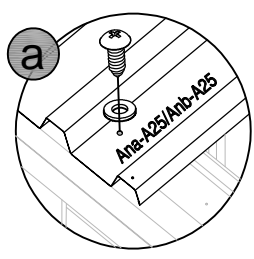

17

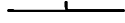

Ana-C29 [x1]



AnbX-C47 [x12]



AnbX-C40 [x12]

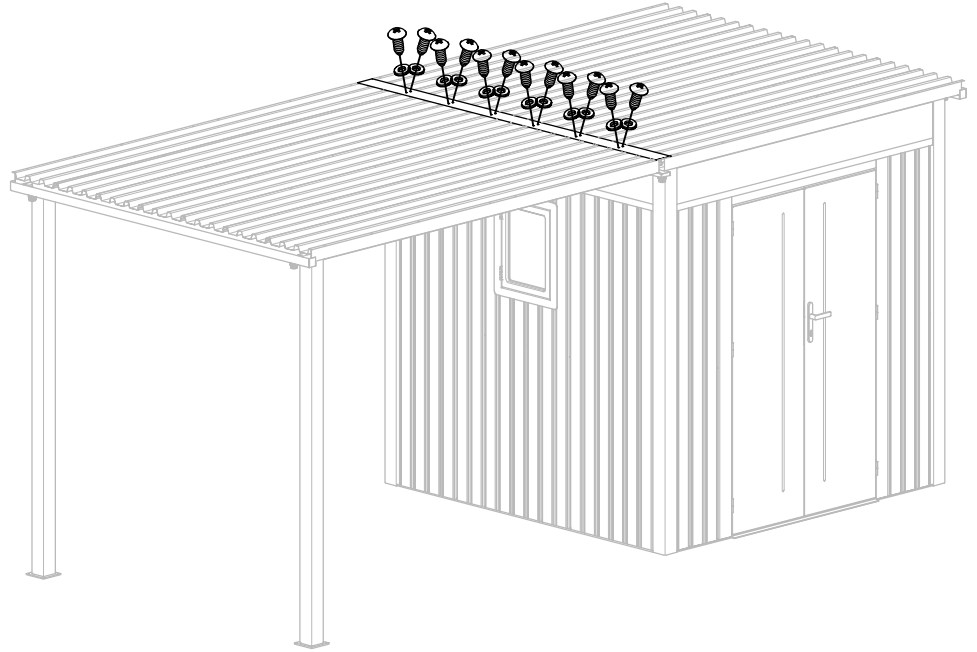
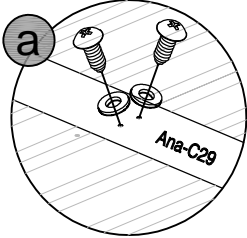

18



Anb-A28 [x1]



Anb-A28a [x1]



Anb-A35 [x2]



Ana-C35a [x2]



Anb-A36 [x2]



AnbX-C41 [x4]



AnbX-C42 [x8]



AnbX-C40 [x12]

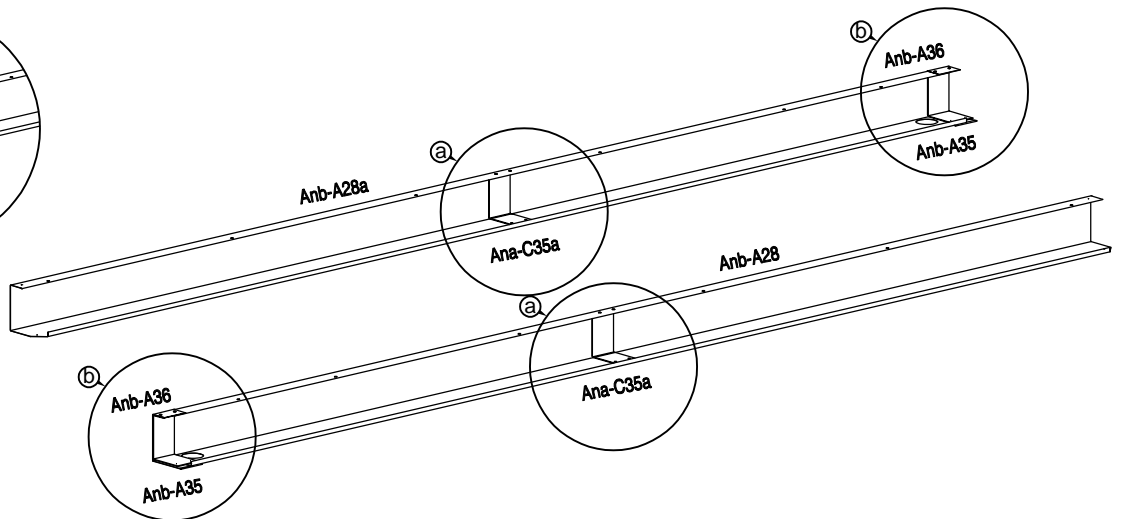
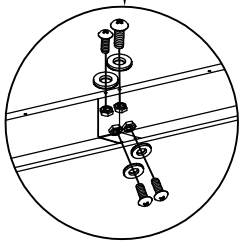
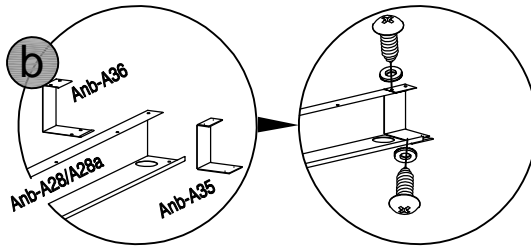
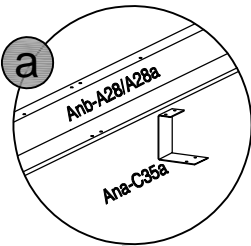

19

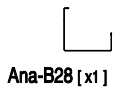

Ana-B28 [x1]



AnbX-C41 [x20]



AnbX-C40 [x20]

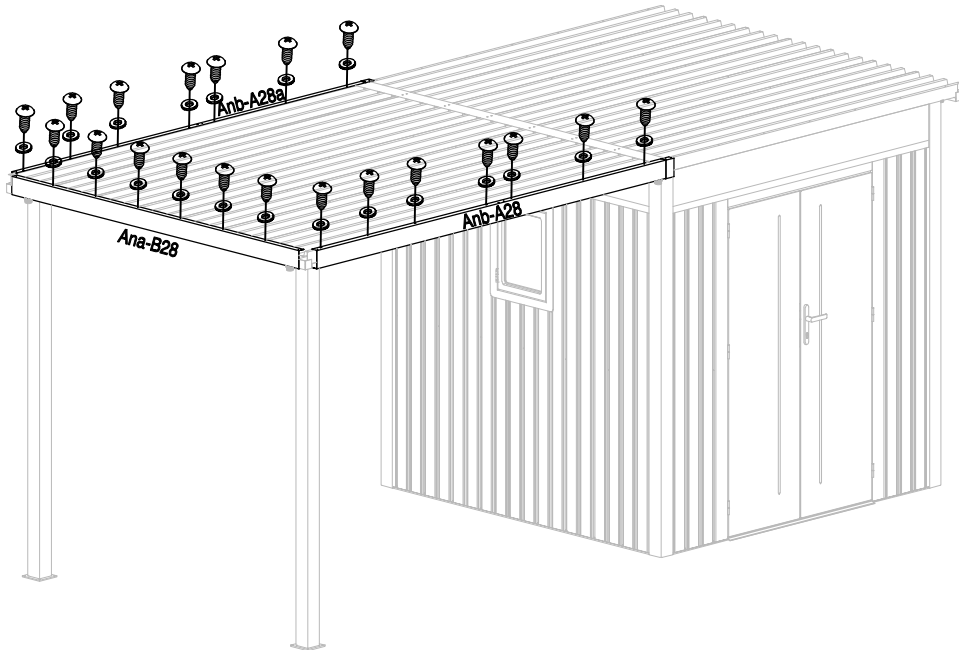
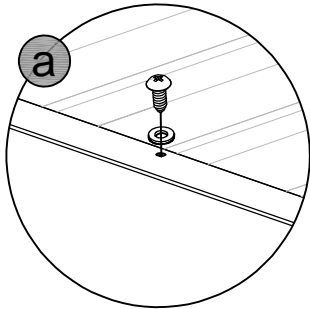

20

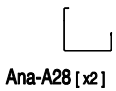

Ana-A28 [x2]



Ana-B28 [x1]



AnbX-C41 [x24]



AnbX-C40 [x24]

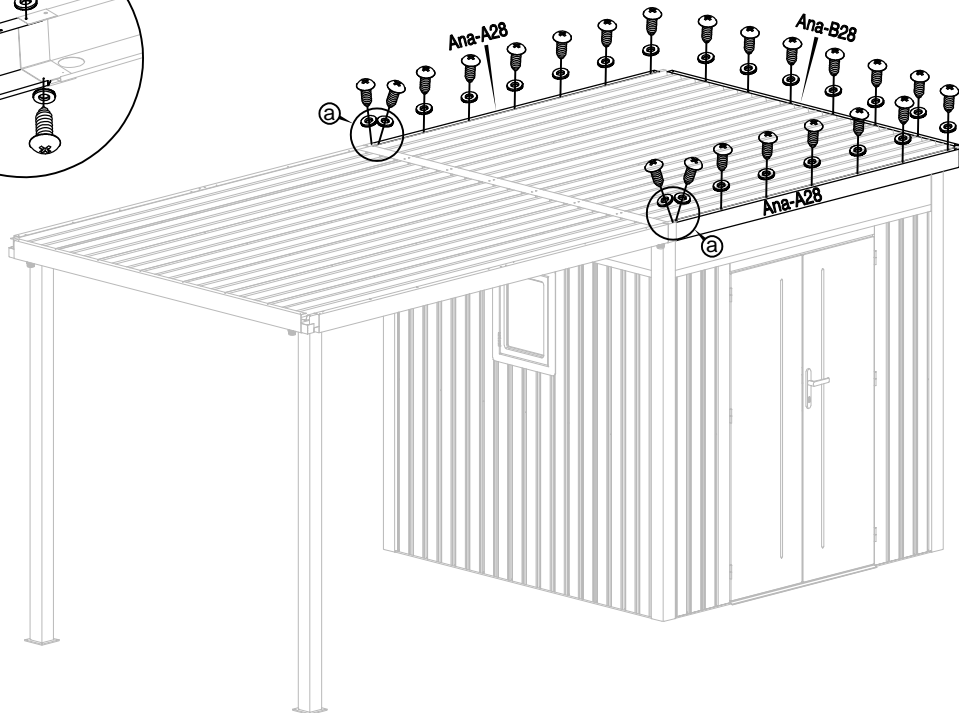
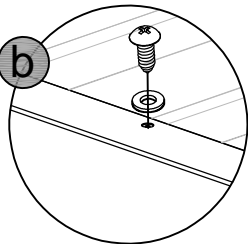
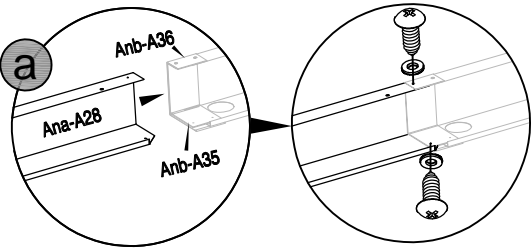

21



Ana-P2 [x4]



AnbX-C41 [x16]

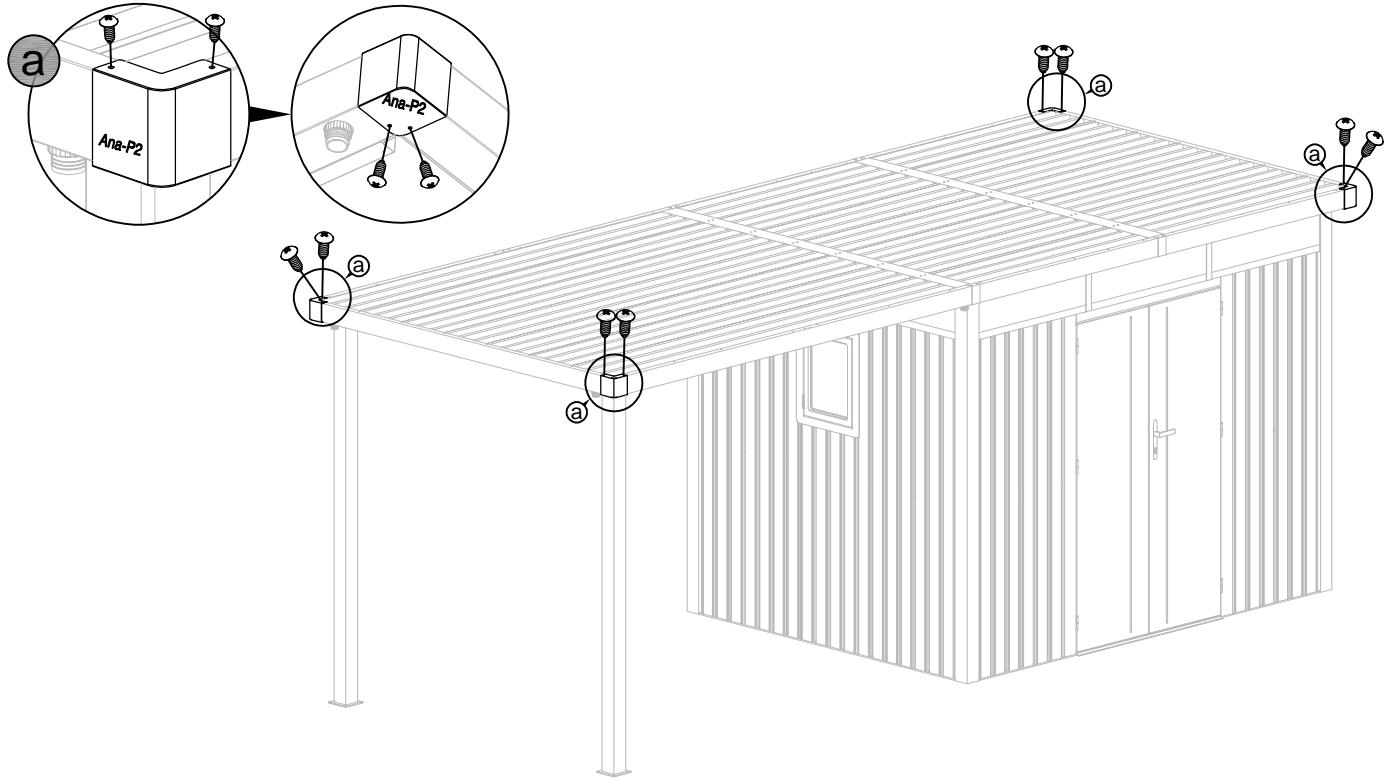

22



Anb-45 [x8]

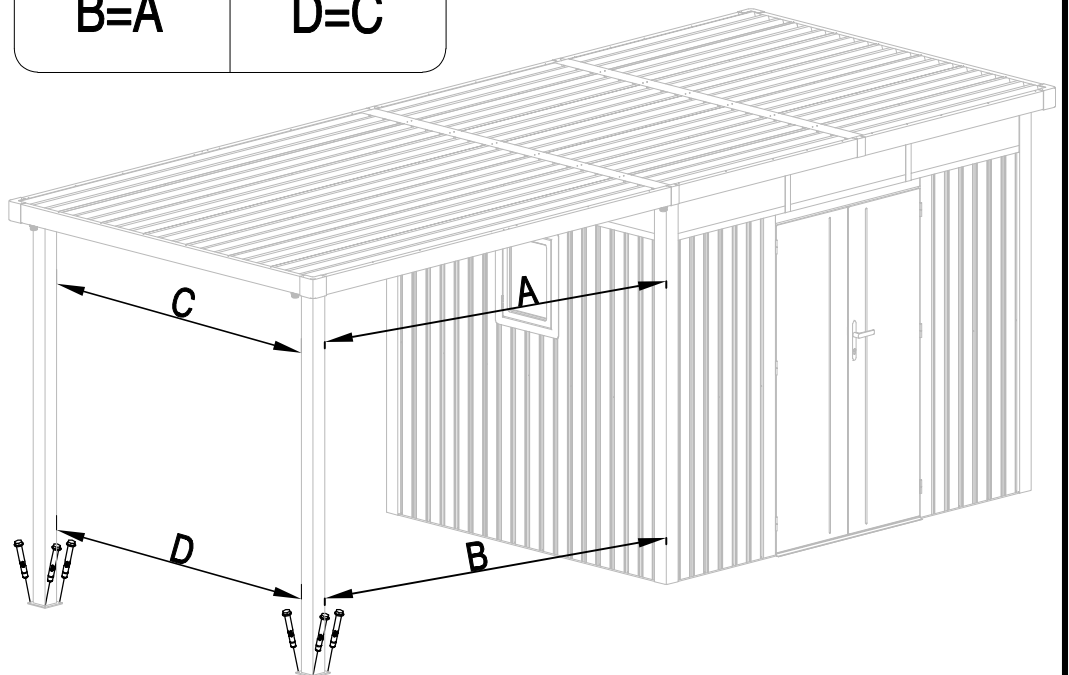
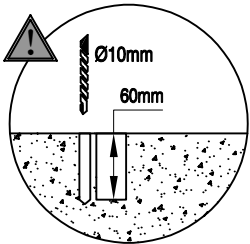
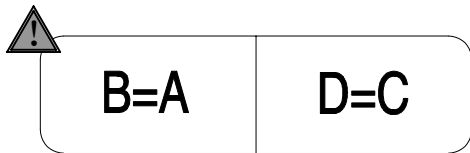
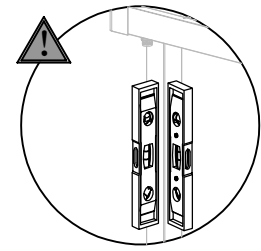



osb onlineshop-baumarkt GmbH

Adresse:
Steinbacher Straße 62
64658 Fürth
Deutschland

Tel: 0049 6253 979920
Email: service@onlineshop-baumarkt.de